

Anschlag links

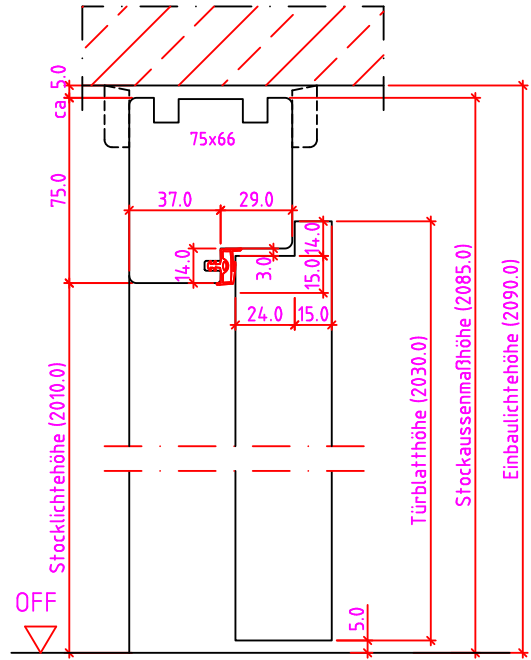

40mm Winkelschiene

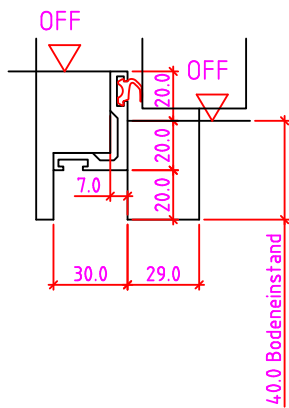

30mm Winkelschiene

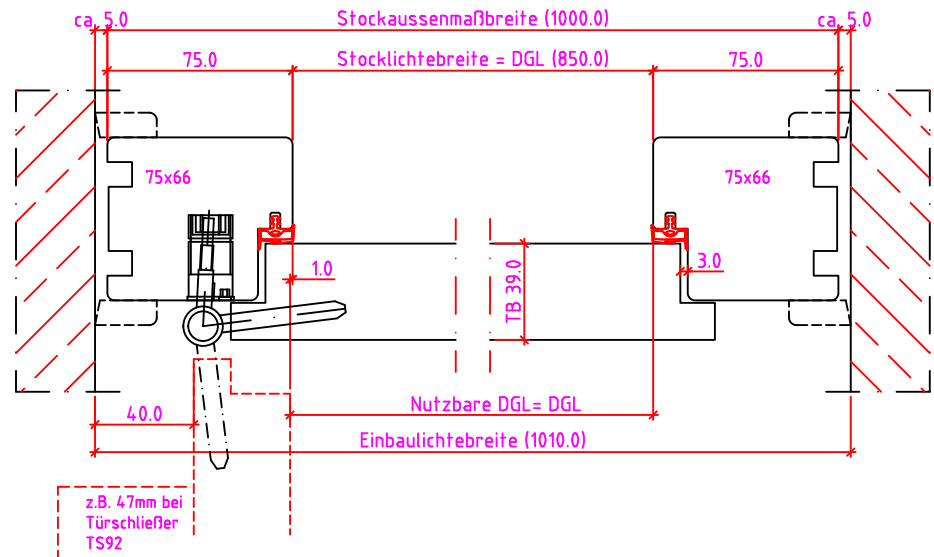
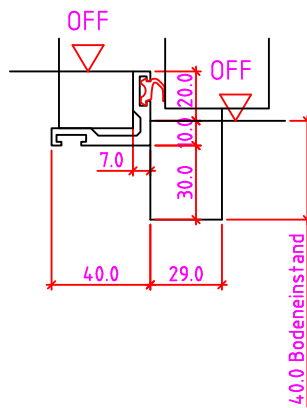

Maßangaben in mm

	Datum	Name	Objekt:	Maßstab:	 <p>Jeld-Wen Türen GmbH A-4582 Spital am Pyhrn</p>
Gez.:	21.11.14	agro	Kunde/Lieferant:		
Gepr.:			AB-Nr.:		
Benennung:	Nutzbare DGL RSTI 75/66 gefälzt mit Türblatt 39mm mit 16er Band Winkelschiene und Bodeneinstand 40mm			Zeichnungs-Nr.	00692989 / A
Bemerkungen:				Ersatz für:	Alle Rechte vorbehalten

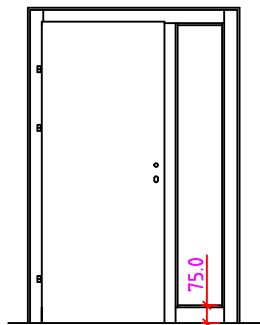

RST 1S-R Anschlag links

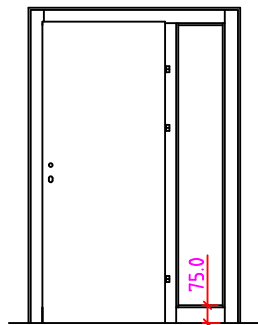

RST 1S-R Anschlag rechts

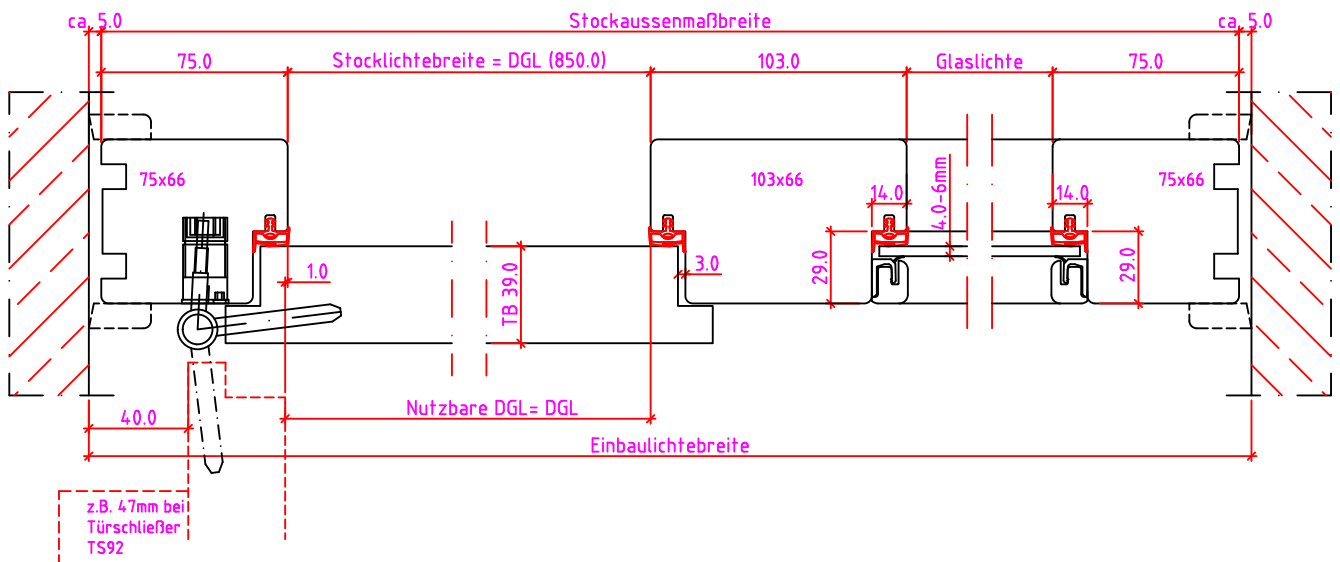
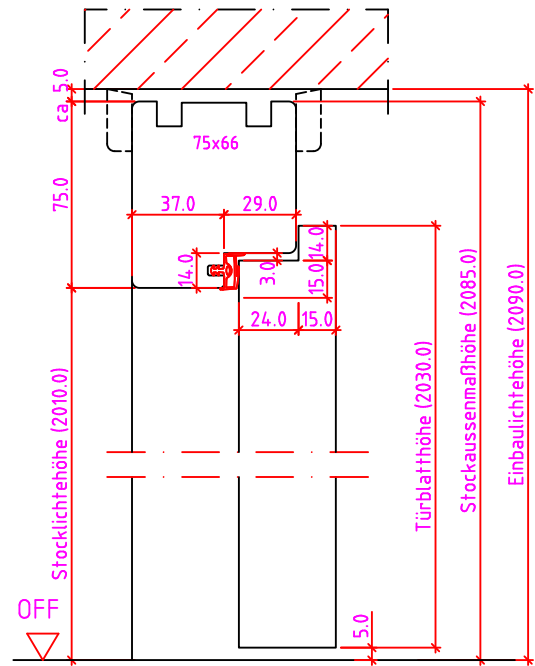

Maßangaben in mm

	Datum	Name	Objekt:	Maßstab:	 <p>Jeld-Wen Türen GmbH A-4582 Spital am Pyhrn</p>
Gez.:	21.11.14	agro	Kunde/Lieferant:		
Gepr.:			AB-Nr.:		
Benennung:	Nutzbare DGL RST1 75/66 gefälzt mit Türblatt 39mm und 16er Band			Zeichnungs-Nr. 00692989 / A	Alle Rechte vorbehalten
Bemerkungen:				Ersatz für:	

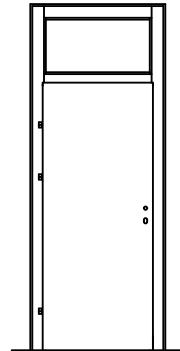

RST-K Anschlag links

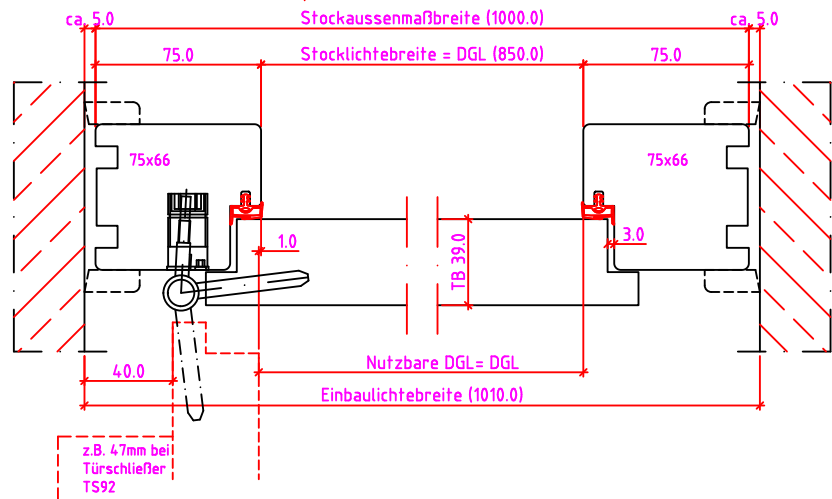
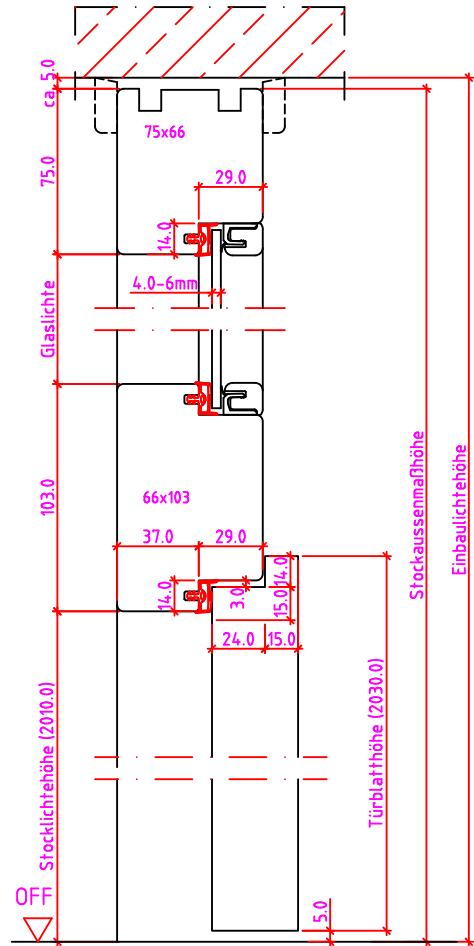
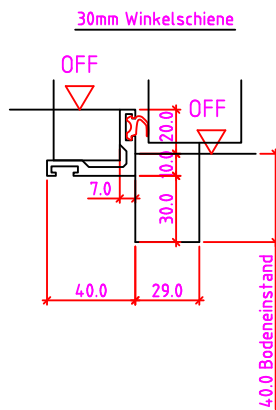
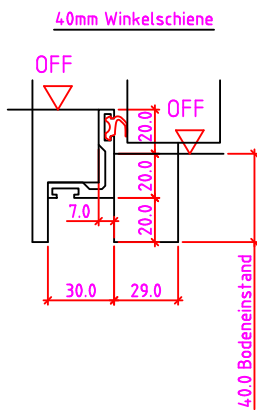

Maßangaben in mm

	Datum	Name	Objekt:	Maßstab:	 <p>Jeld-Wen Türen GmbH A-4582 Spital am Pyhrn</p>
Gez.:	21.11.14	agro	Kunde/Lieferant:	00692989 / A	
Gepr.:	..		AB-Nr.:		
Benennung: Nutzbare DGL RSTI 75/66 gefälzt mit Türblatt 39mm und 16er Band Winkelschiene und Bodeneinstand 40mm				Zeichnungs-Nr.	
Bemerkungen:				Ersatz für:	
				Alle Rechte vorbehalten	

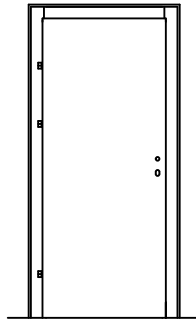

Anschlag links

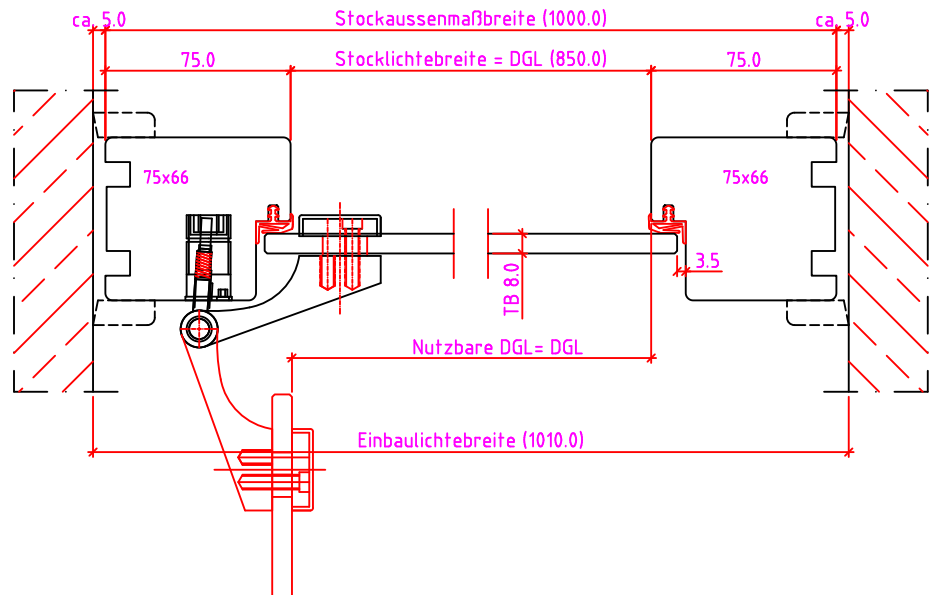
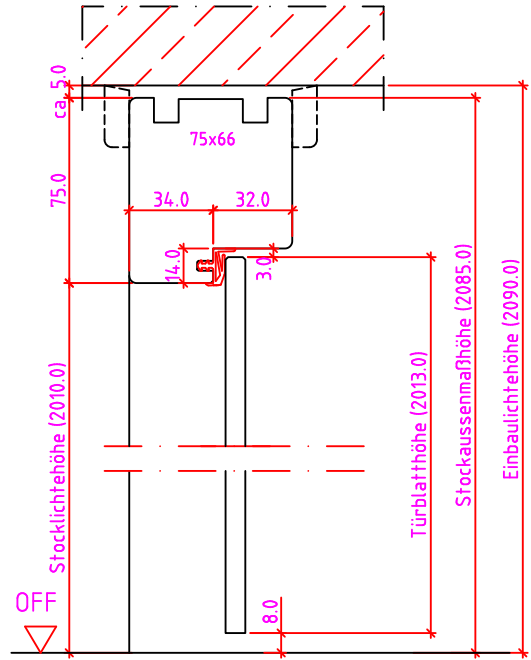

Maßangaben in mm

	Datum	Name	Objekt:	Maßstab:	 <p>Jeld-Wen Türen GmbH A-4582 Spital am Pyhrn</p>
Gez.:	11.12.14	agro	Kunde/Lieferant:		
Gepr.:	.	.	AB-Nr.:		
Benennung:	Nutzbare DGL RSTI 75/66 GT Türblatt 8mm mit Vario Band + Incanto Bandaufnahme			Zeichnungs-Nr. 00695004 / A	
Bemerkungen:				Ersatz für:	Alle Rechte vorbehalten

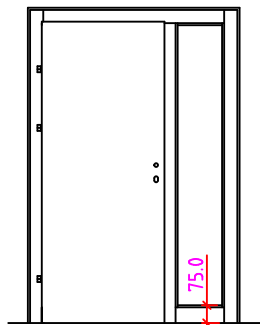

RST 1S-R Anschlag links

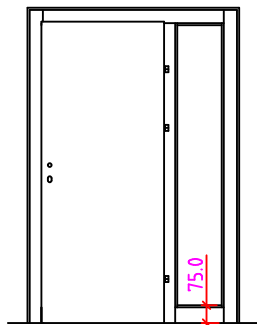

RST 1S-R Anschlag rechts

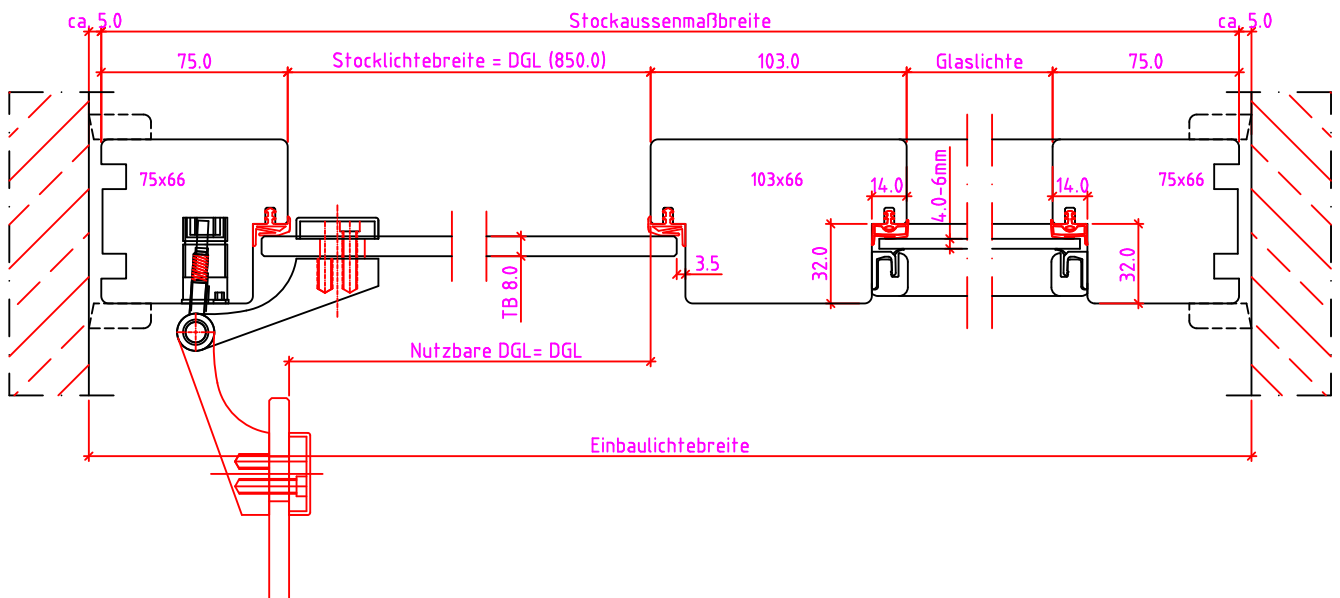
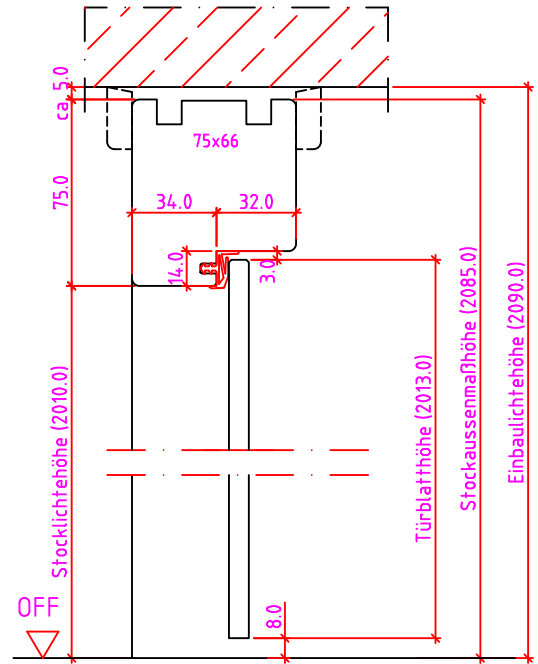

Maßangaben in mm

	Datum	Name	Objekt:	Maßstab:	 <p>Jeld-Wen Türen GmbH A-4582 Spital am Pyhrn</p>
Gez.:	11.12.14	agro	Kunde/Lieferant:		
Gepr.:	..		AB-Nr.:		
Benennung:	<p>Nutzbare DGL RSTI 75/66 GT Türblatt 8mm mit Vario Band + Incanto Bandaufnahme</p>			Zeichnungs-Nr.	00695004 / A
Bemerkungen:				Ersatz für:	Alle Rechte vorbehalten

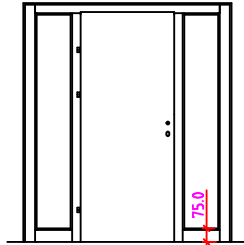

RST 2S Anschlag links

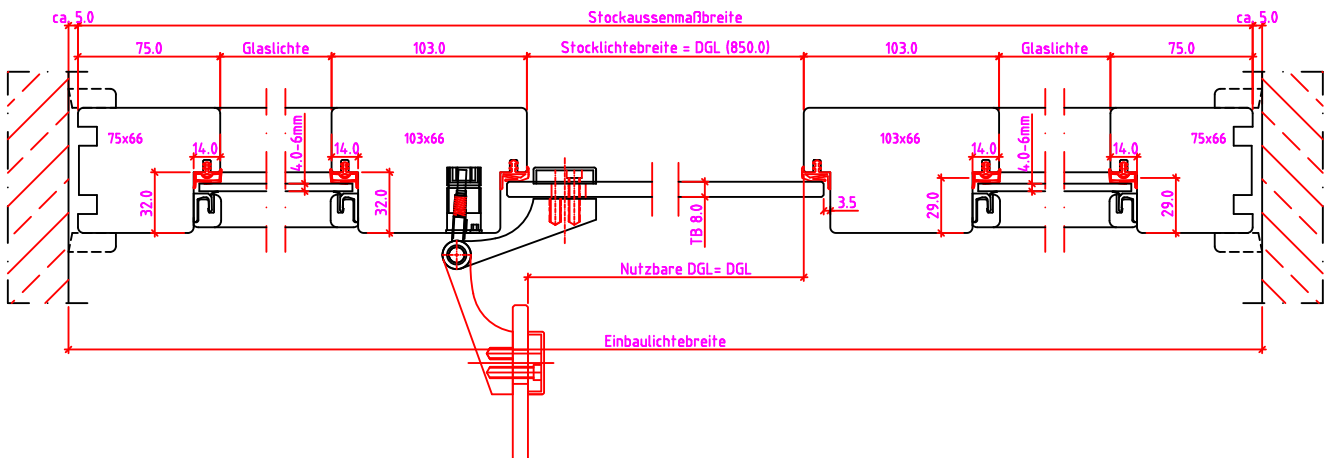
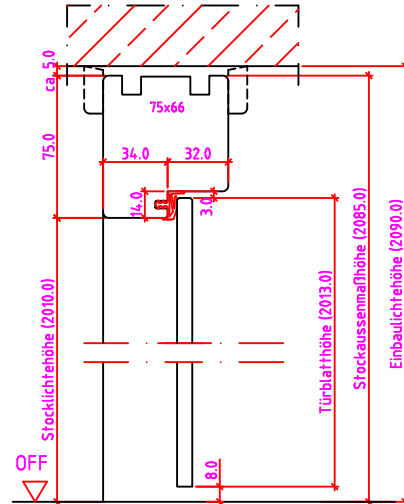

Maßangaben in mm

	Datum	Name	Objekt:	Maßstab:	 <p>Jeld-Wen Türen GmbH A-4582 Spital am Pyhrn</p>
Gez.:	11.12.14	agro	Kunde/Lieferant:		
Gepr.:	..		AB-Nr.:		
Benennung:	Nutzbare DGL RSTI 75/66 GT Türblatt 8mm mit Vario Band + Incanto Bandaufnahme			Zeichnungs-Nr. 00695004 / A	
Bemerkungen:				Ersatz für:	Alle Rechte vorbehalten

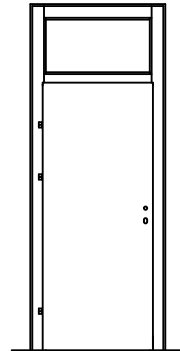

RST-K Anschlag links

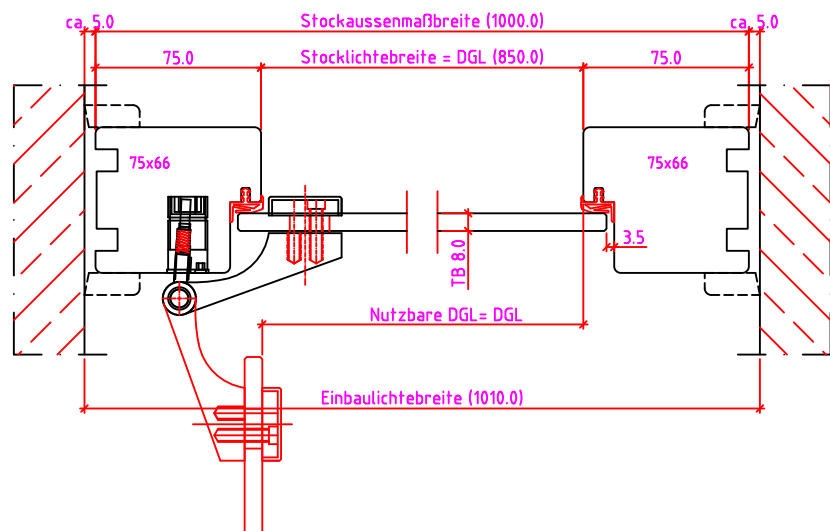
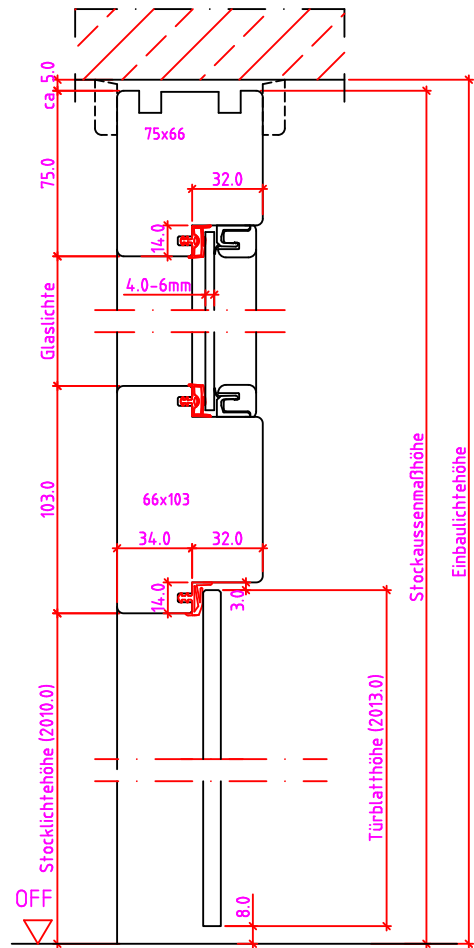

Maßangaben in mm

	Datum	Name	Objekt:	Maßstab:	 <p>Jeld-Wen Türen GmbH A-4582 Spital am Pyhrn</p>
Gez.:	11.12.14	agro	Kunde/Lieferant:		
Gepr.:	.	.	AB-Nr.:		
Benennung:	Nutzbare DGL RSTI 75/66 GT Türblatt 8mm mit Vario Band + Incanto Bandaufnahme			Zeichnungs-Nr. 00695004 / A	
Bemerkungen:				Ersatz für:	Alle Rechte vorbehalten

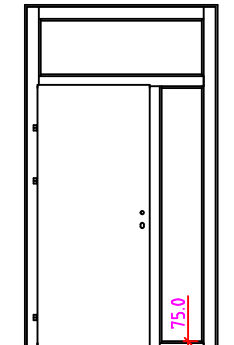

RST 1SK-R Anschlag links

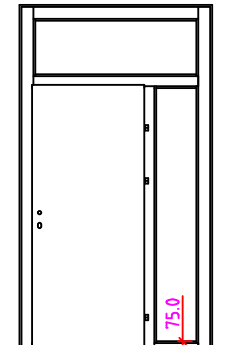

RST 1SK-R Anschlag rechts

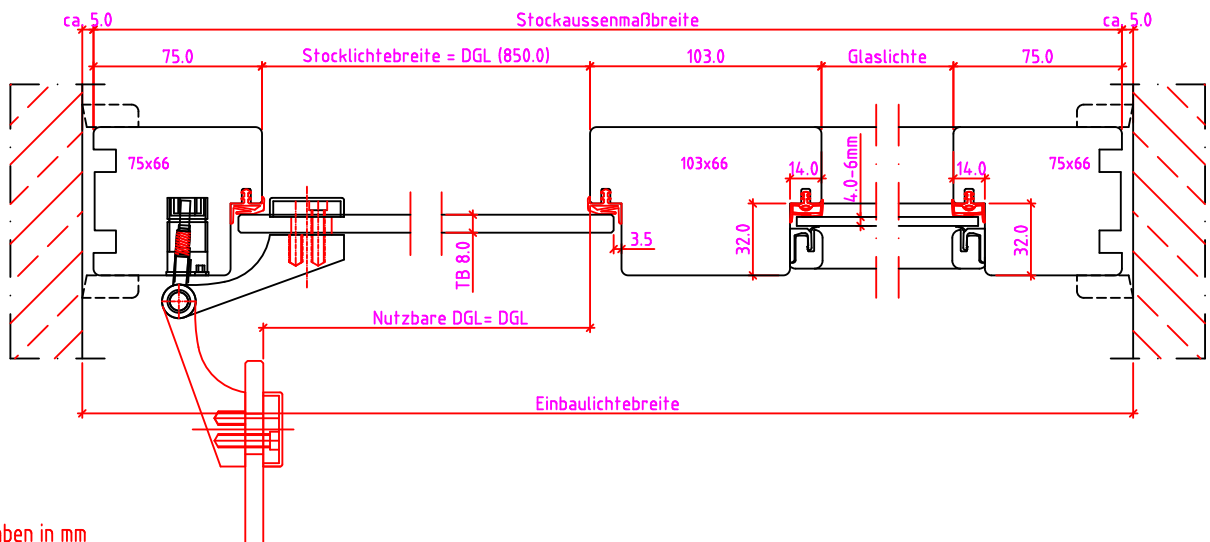
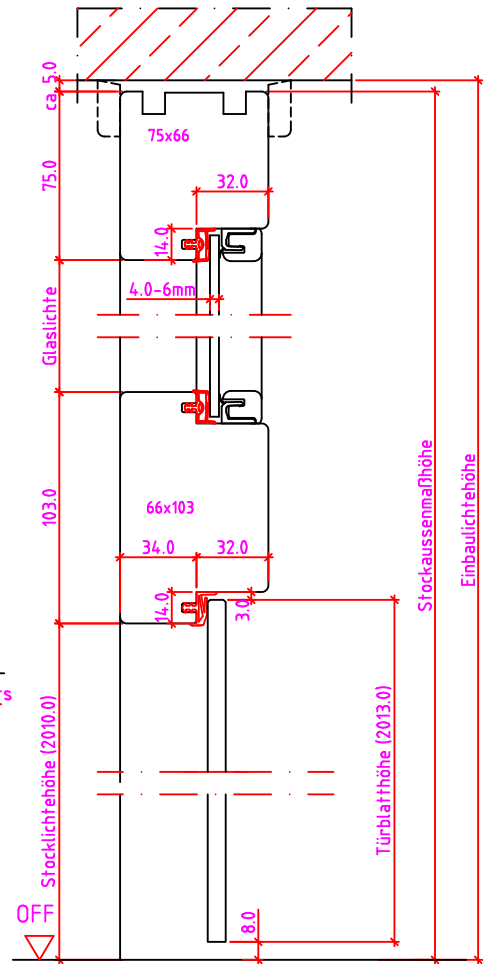

Maßangaben in mm

	Datum	Name	Objekt:	Maßstab:	<p>Jeld-Wen Türen GmbH A-4582 Spital am Pyhrn</p>
Gez.:	11.12.14	agro	Kunde/Lieferant:		
Gepr.:			AB-Nr.:		
Benennung:	Nutzbare DGL RSTI 75/66 GT Türblatt 8mm mit Vario Band + Incanto Bandaufnahme			Zeichnungs-Nr. 00695004 / A	
Bemerkungen:				Ersatz für:	Alle Rechte vorbehalten

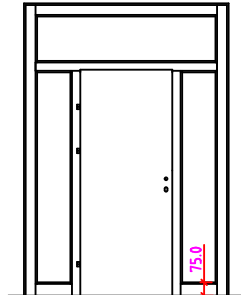

RST 2SK Anschlag links

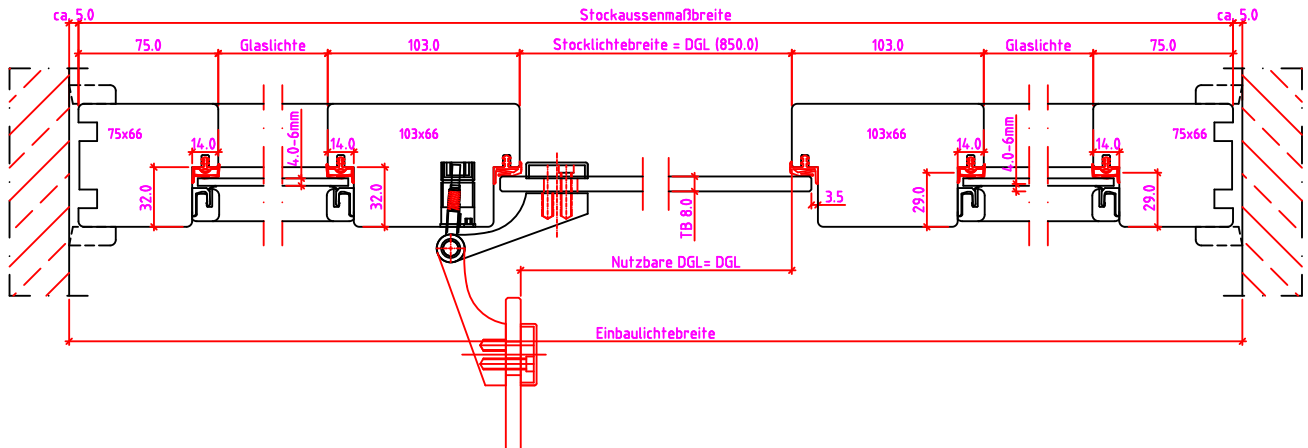
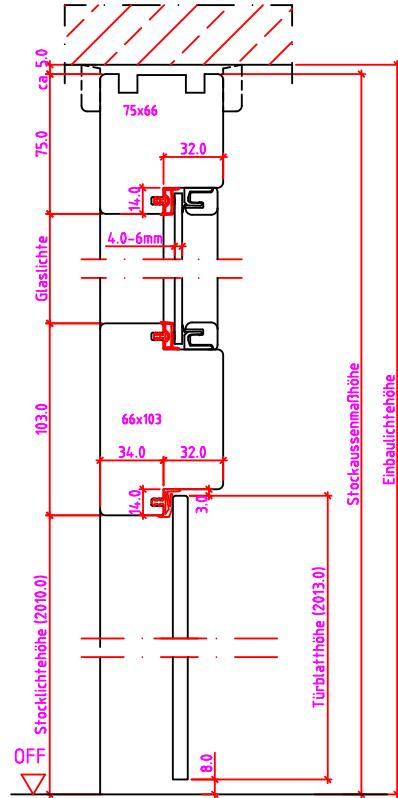

Maßangaben in mm

	Datum	Name	Objekt:	Maßstab:	 Jeld-Wen Türen GmbH A-4582 Spital am Pyhrn
Gez.:	11.12.14	agro	Kunde/Lieferant:		
Gepr.:	. . .		AB-Nr.:		
Benennung: Nutzbare DGL RSTI 75/66 GT Türblatt 8mm mit Vario Band + Incanto Bandaufnahme				Zeichnungs-Nr. 00695004 / A	
Bemerkungen:				Ersatz für:	Alle Rechte vorbehalten

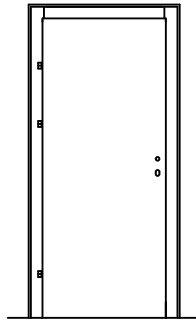

Anschlag links

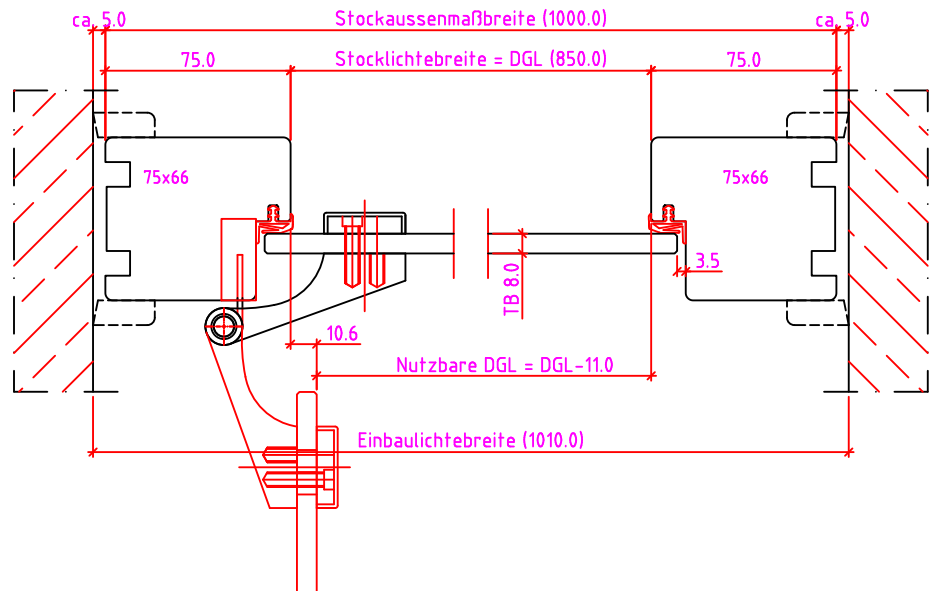
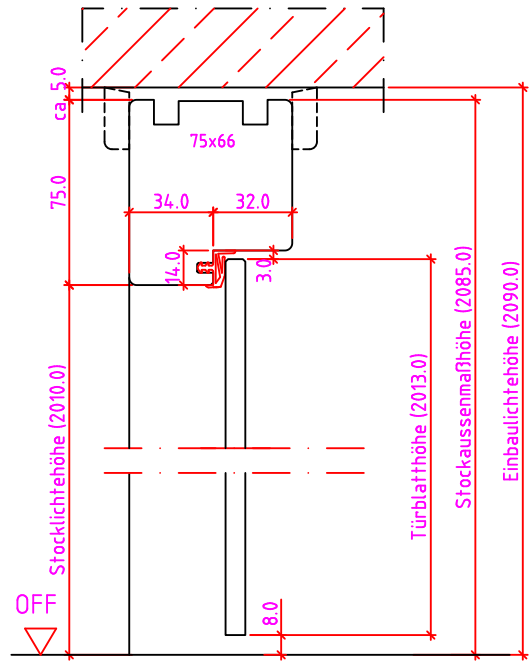

Maßangaben in mm

	Datum	Name	Objekt:	Maßstab:	 <p>Jeld-Wen Türen GmbH A-4582 Spital am Pyhrn</p>
Gez.:	11.12.14	agro	Kunde/Lieferant:		
Gepr.:	.	.	AB-Nr.:		
Benennung:	Nutzbare DGL RSTI 75/66 GT-M Türblatt 8mm mit Vario Band + V7888 Bandaufnahme			Zeichnungs-Nr. 00695034 / A	
Bemerkungen:				Ersatz für:	Alle Rechte vorbehalten

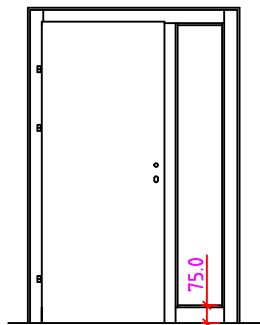

RST 1S-R Anschlag links

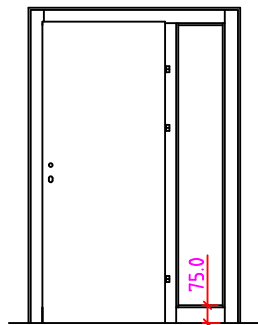

RST 1S-R Anschlag rechts

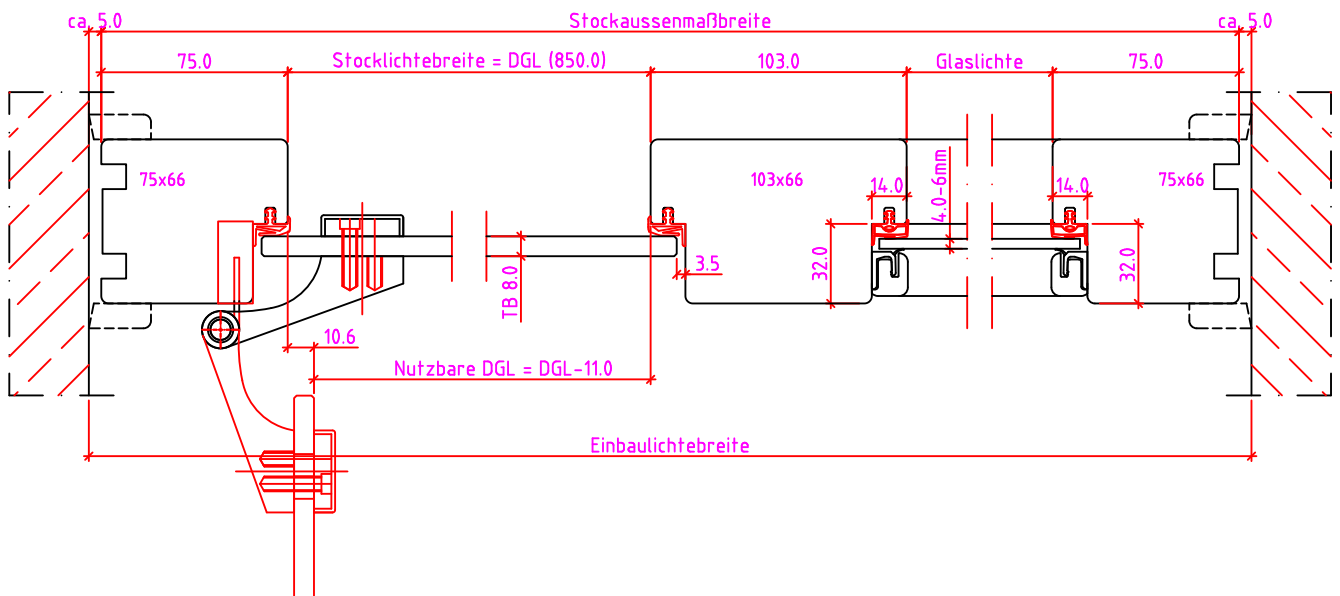
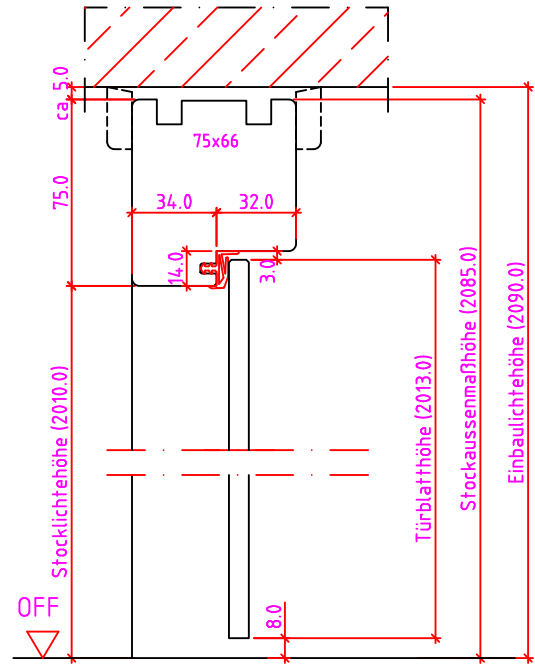

Maßangaben in mm

	Datum	Name	Objekt:	Maßstab:	 <p>Jeld-Wen Türen GmbH A-4582 Spital am Pyhrn</p>
Gez.:	11.12.14	agro	Kunde/Lieferant:		
Gepr.:	.	.	AB-Nr.:		
Benennung:	Nutzbare DGL RSTI 75/66 GT-M Türblatt 8mm mit Vario Band + V7888 Bandaufnahme			Zeichnungs-Nr. 00695034 / A	
Bemerkungen:				Ersatz für:	Alle Rechte vorbehalten

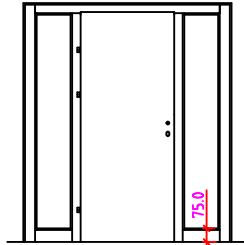

RST 2S Anschlag links

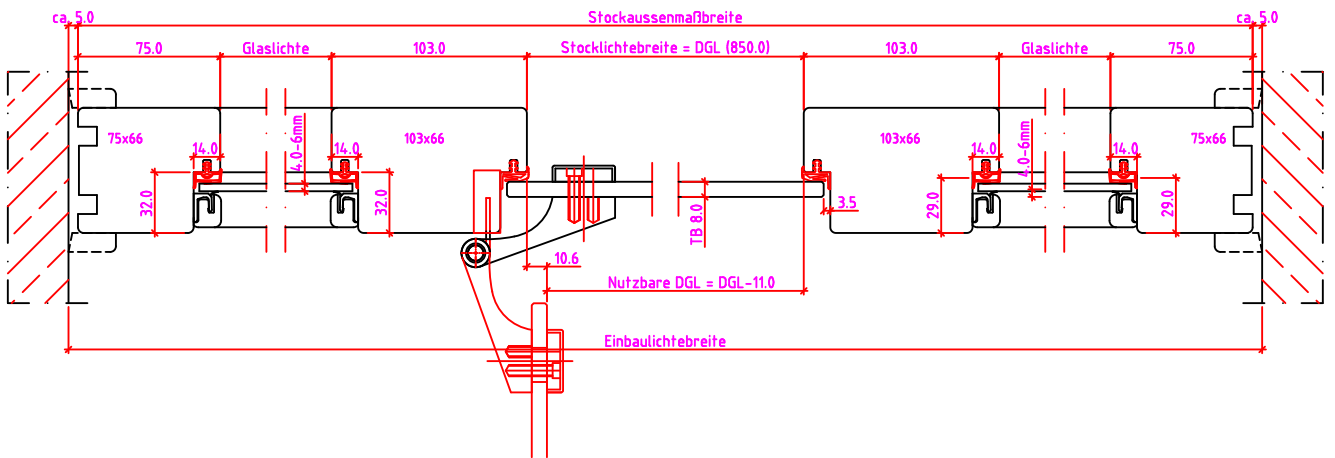
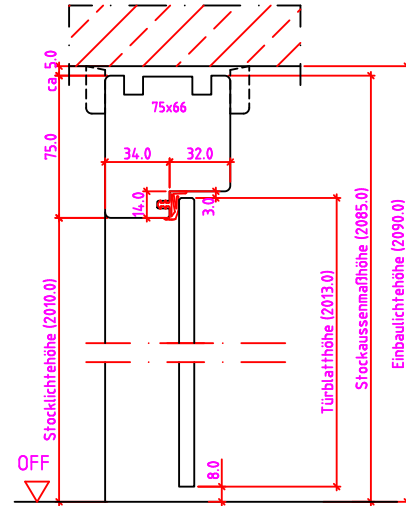

Maßangaben in mm

	Datum	Name	Objekt:	Maßstab:	 <p>Jeld-Wen Türen GmbH A-4582 Spital am Pyhrn</p>
Gez.:	11.12.14	agro	Kunde/Lieferant:		
Gepr.:	.	.	AB-Nr.:		
Benennung:	Nutzbare DGL RSTI 75/66 GT-M Türblatt 8mm mit Vario Band + V7888 Bandaufnahme			Zeichnungs-Nr. 00695034 / A	
Bemerkungen:				Ersatz für:	Alle Rechte vorbehalten

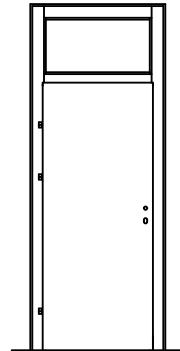

RST-K Anschlag links

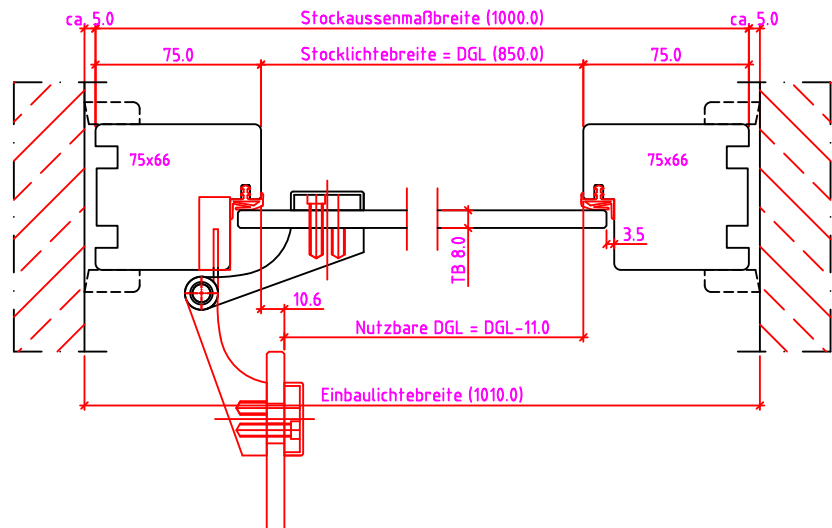
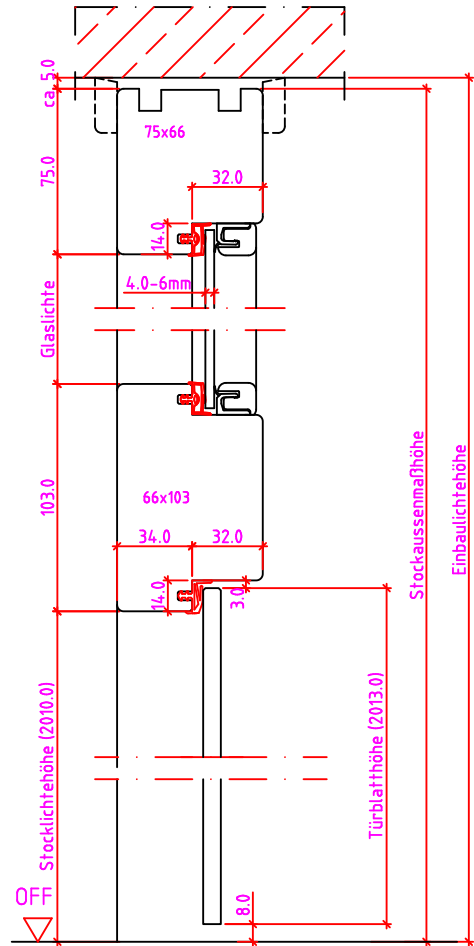

Maßangaben in mm

	Datum	Name	Objekt:	Maßstab:	 <p>Jeld-Wen Türen GmbH A-4582 Spital am Pyhrn</p>
Gez.:	11.12.14	agro	Kunde/Lieferant:		
Gepr.:	.	.	AB-Nr.:		
Benennung:	Nutzbare DGL RSTI 75/66 GT-M Türblatt 8mm mit Vario Band + V7888 Bandaufnahme			Zeichnungs-Nr. 00695034 / A	
Bemerkungen:				Ersatz für:	Alle Rechte vorbehalten

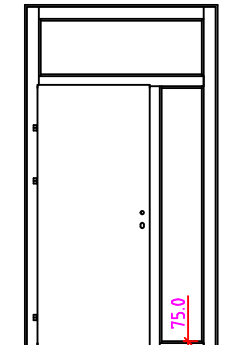

RST 1SK-R Anschlag links

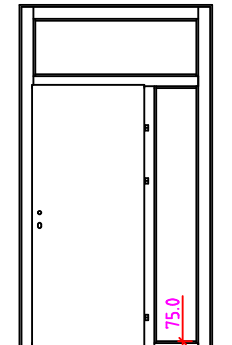

RST 1SK-R Anschlag rechts

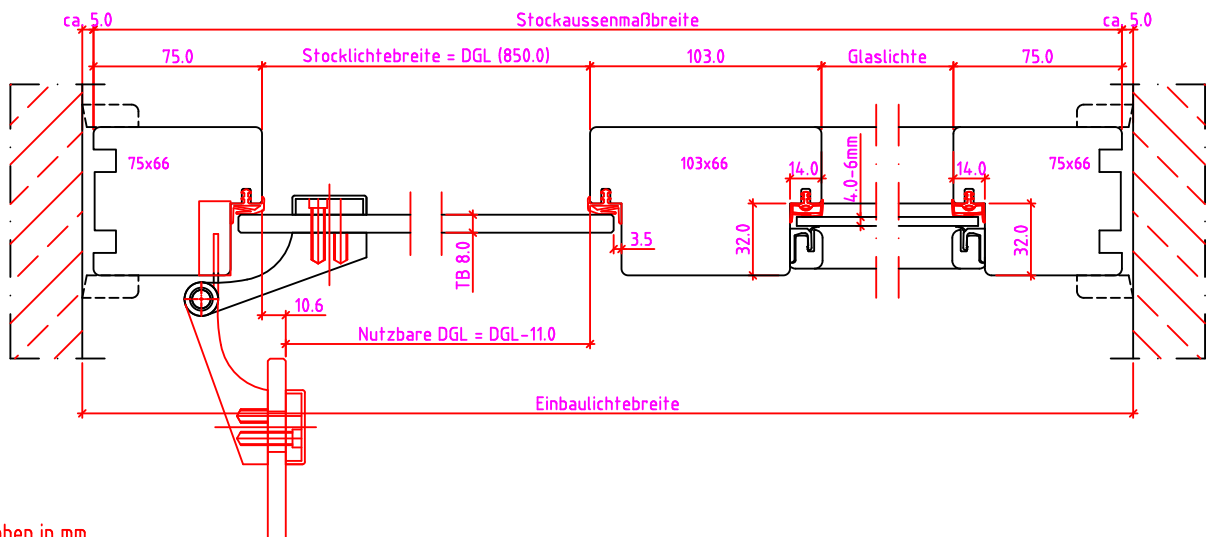
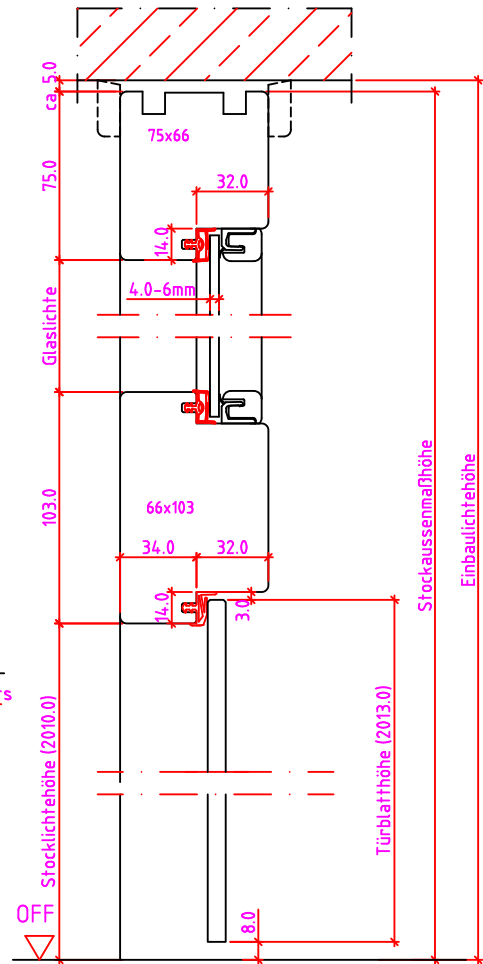

Maßangaben in mm

	Datum	Name	Objekt:	Maßstab:	 <p>Jeld-Wen Türen GmbH A-4582 Spital am Pyhrn</p>
Gez.:	11.12.14	agro	Kunde/Lieferant:		
Gepr.:			AB-Nr.:		
Benennung: Nutzbare DGL RSTI 75/66 GT-M Türblatt 8mm mit Vario Band + V7888 Bandaufnahme				Zeichnungs-Nr. 00695034 / A	
Bemerkungen:				Ersatz für:	Alle Rechte vorbehalten

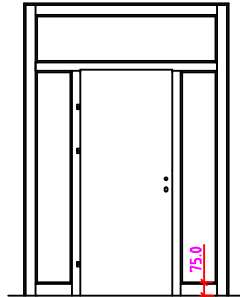

RST 2SK Anschlag links

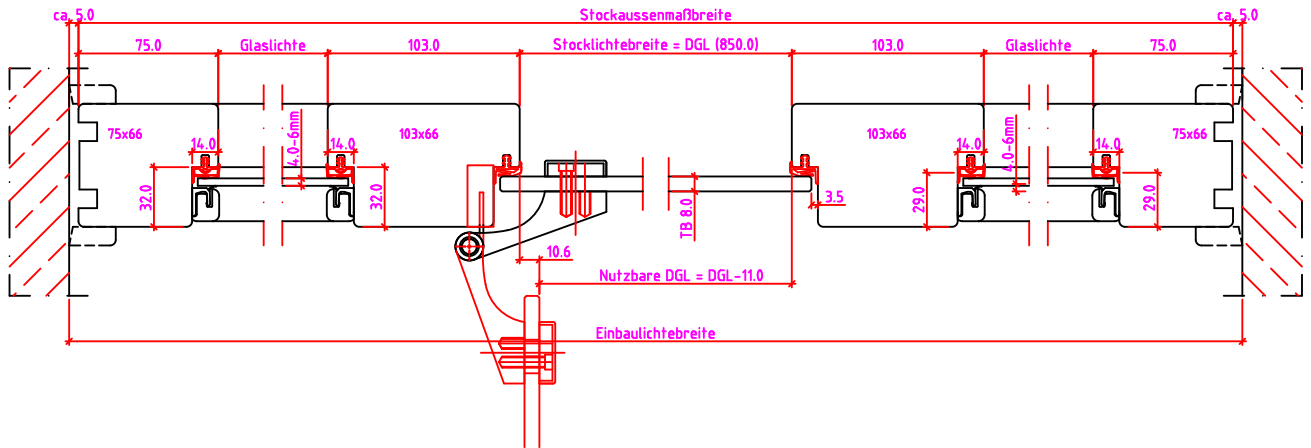
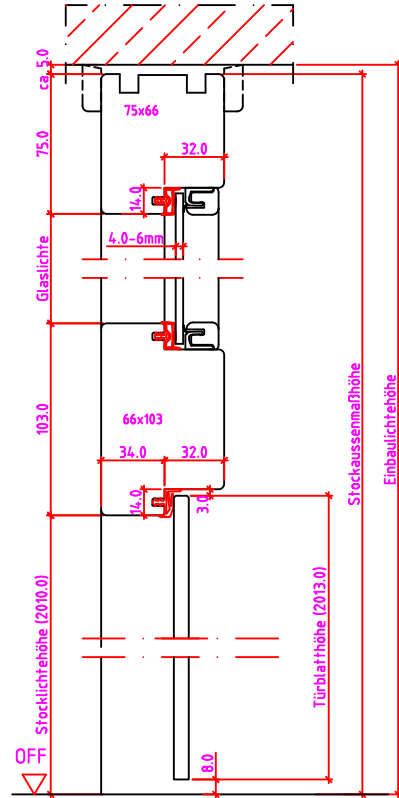

Maßangaben in mm

	Datum	Name	Objekt:	Maßstab:	 <p>Jeld-Wen Türen GmbH A-4582 Spital am Pyhrn</p>
Gez.:	11.12.14	agro	Kunde/Lieferant:		
Gepr.:	.	.	AB-Nr.:		
Benennung: Nutzbare DGL RSTI 75/66 GT-M Türblatt 8mm mit Vario Band + V7888 Bandaufnahme				Zeichnungs-Nr. 00695034 / A	
Bemerkungen:				Ersatz für:	Alle Rechte vorbehalten

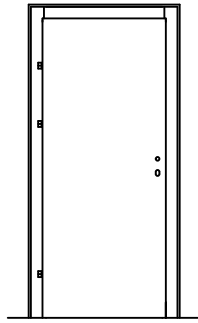

Anschlag links

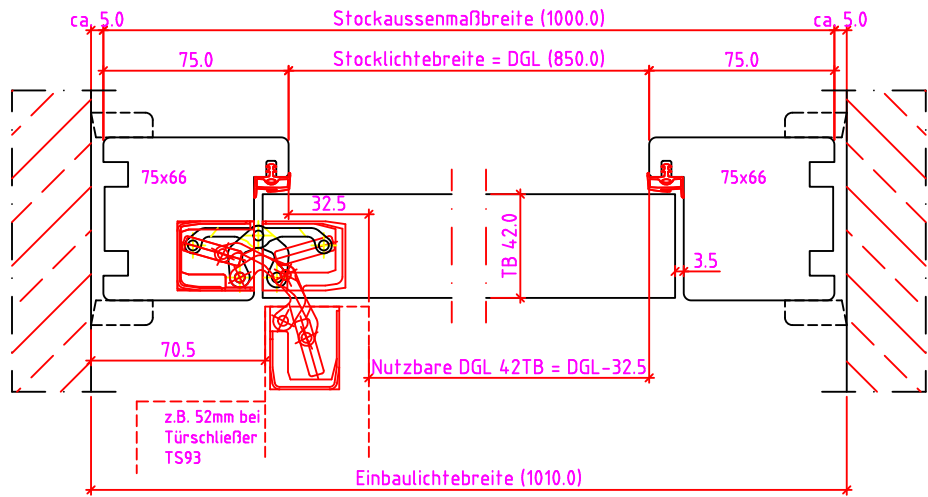
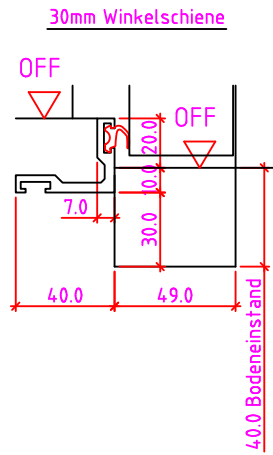
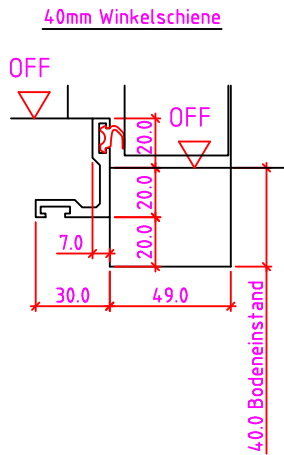
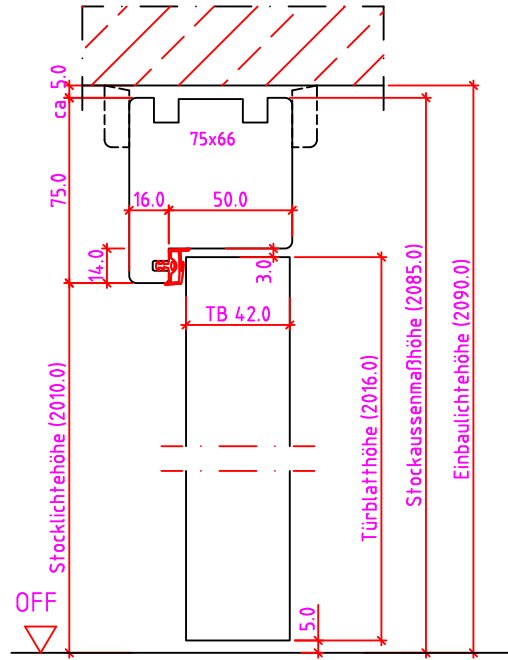

Maßangaben in mm

	Datum	Name	Objekt:	Maßstab:	 <p>Jeld-Wen Türen GmbH A-4582 Spital am Pyhrn</p>
Gez.:	10.12.14	agro	Kunde/Lieferant:		
Gepr.:	.	.	AB-Nr.:		
Benennung:	Nutzbare DGL RSTI 75/66 Modul mit Türblatt 42mm mit TE340 und Bodeneinstand 40mm			Zeichnungs-Nr. 00694975 / A	
Bemerkungen:				Ersatz für:	Alle Rechte vorbehalten

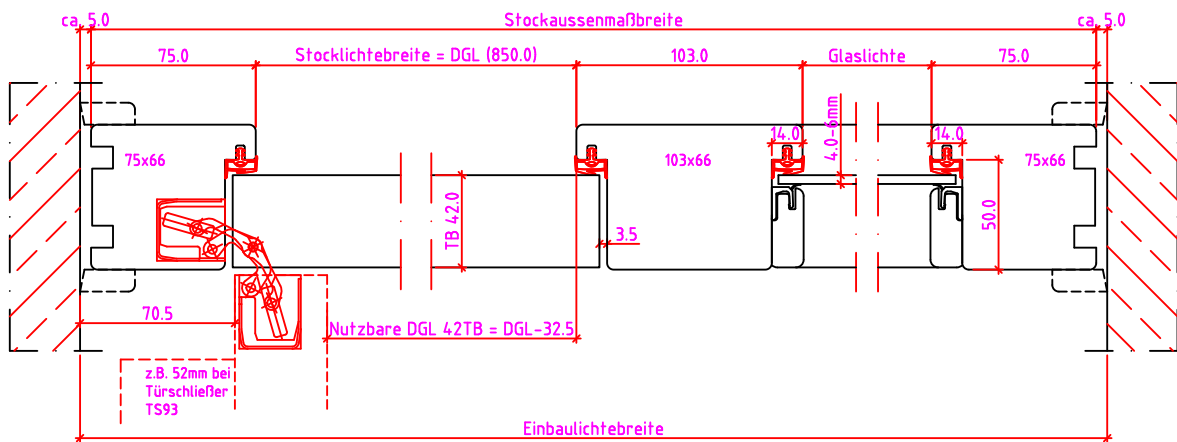
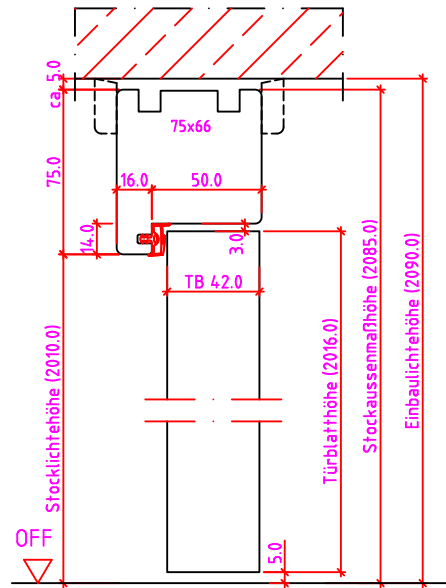
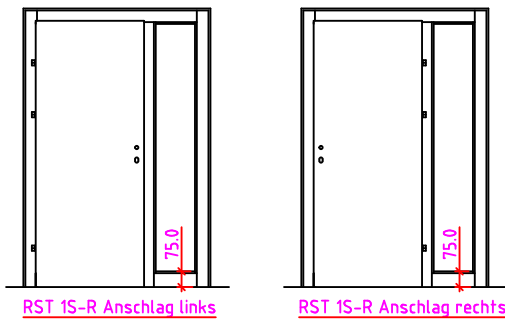

Maßangaben in mm

	Datum	Name	Objekt:	Maßstab:	 Jeld-Wen Türen GmbH A-4582 Spital am Pyhrn
Gez.:	10.12.14	agro	Kunde/Lieferant:		
Gepr.:	.	.	AB-Nr.:		
Benennung:	Nutzbare DGL RST1 75/66 Modul mit Türblatt 42mm und TE340 Band			Zeichnungs-Nr. 00694975 / A	
Bemerkungen:				Ersatz für:	Alle Rechte vorbehalten

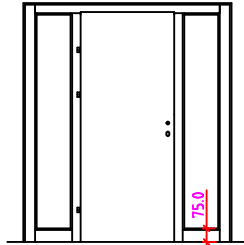

RST 2S Anschlag links

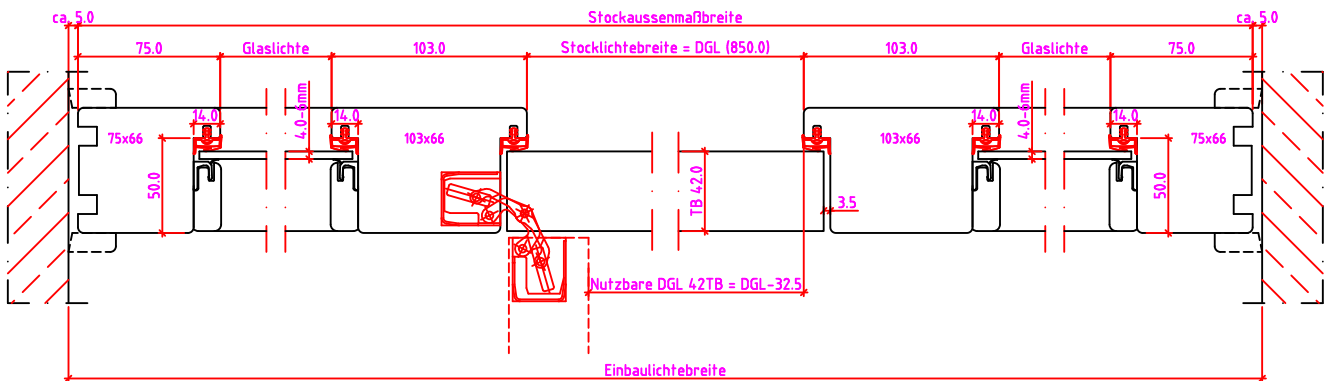
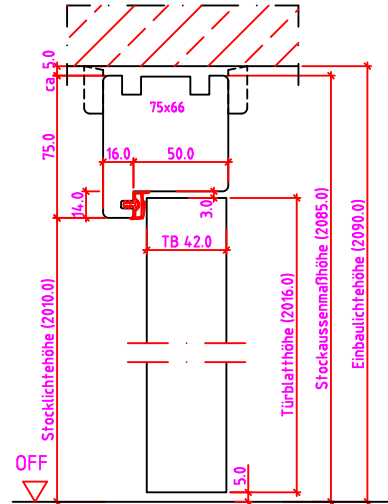

Maßangaben in mm

	Datum	Name	Objekt:	Maßstab:	 <p>Jeld-Wen Türen GmbH A-4582 Spital am Pyhrn</p>
Gez.:	10.12.14	agro	Kunde/Lieferant:		
Gepr.:	..		AB-Nr.:		
Benennung:	Nutzbare DGL RST1 75/66 Modul mit Türblatt 42mm und TE340 Band			Zeichnungs-Nr. 00694975 / A	
Bemerkungen:				Ersatz für:	Alle Rechte vorbehalten

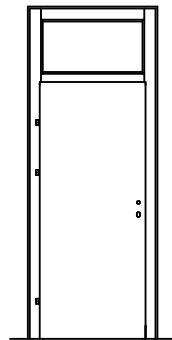

RST-K Anschlag links

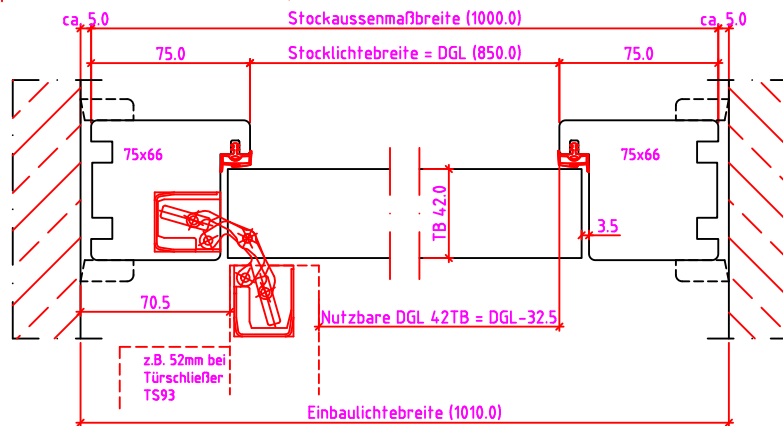
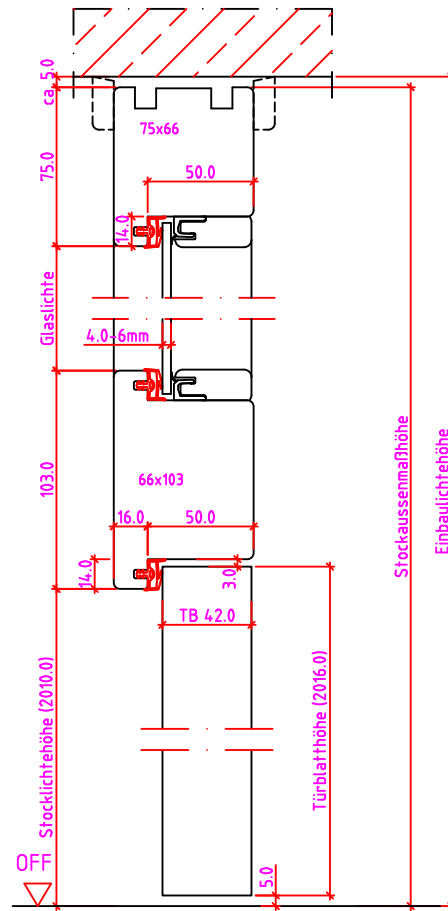
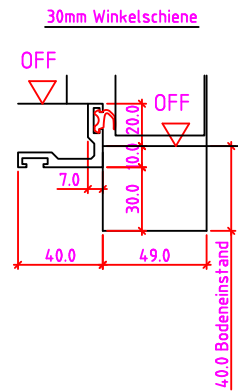
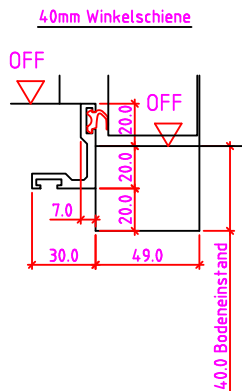

Maßangaben in mm

	Datum	Name	Objekt:	Maßstab:
Gez.:	10.12.14	agro	Kunde/Lieferant:	
Gepr.:	..		AB-Nr.:	
Benennung:	Nutzbare DGL RST1 75/66 Modul mit Türblatt 42mm und TE340 Band			Zeichnungs-Nr. 00694975 / A
Bemerkungen:				Ersatz für:



Jeld-Wen Türen GmbH
A-4582 Spital am Pyhrn

Alle Rechte vorbehalten

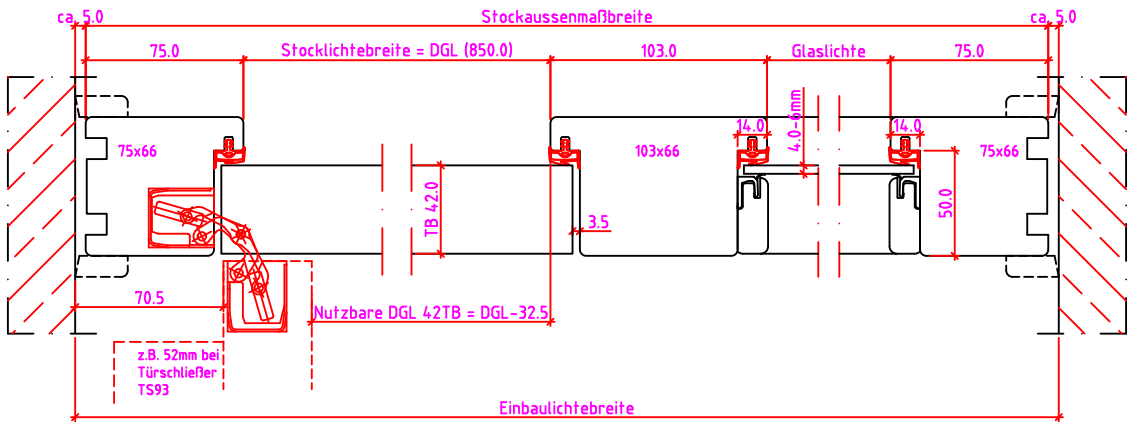
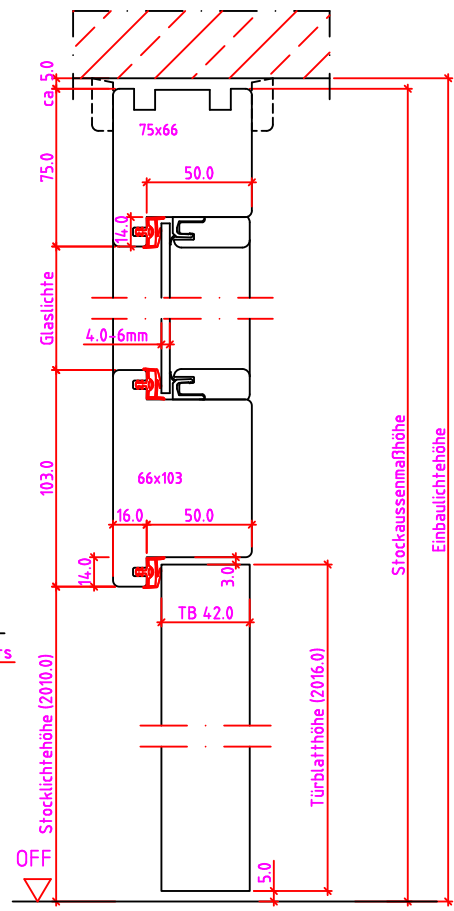

Maßangaben in mm

	Datum	Name	Objekt:	Maßstab:
Gez.:	10.12.14	agro	Kunde/Lieferant:	
Gepr.:			AB-Nr.:	
Benennung:	Nutzbare DGL RSTI 75/66 Modul mit Türblatt 42mm und TE340 Band			Zeichnungs-Nr. 00694975 / A
Bemerkungen:				Ersatz für:

DANA®

Jeld-Wen Türen GmbH
A-4582 Spital am Pyhrn

Alle Rechte vorbehalten

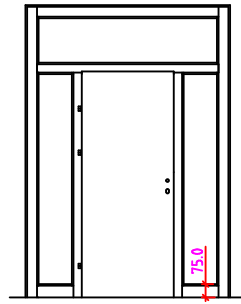

RST 2SK Anschlag links

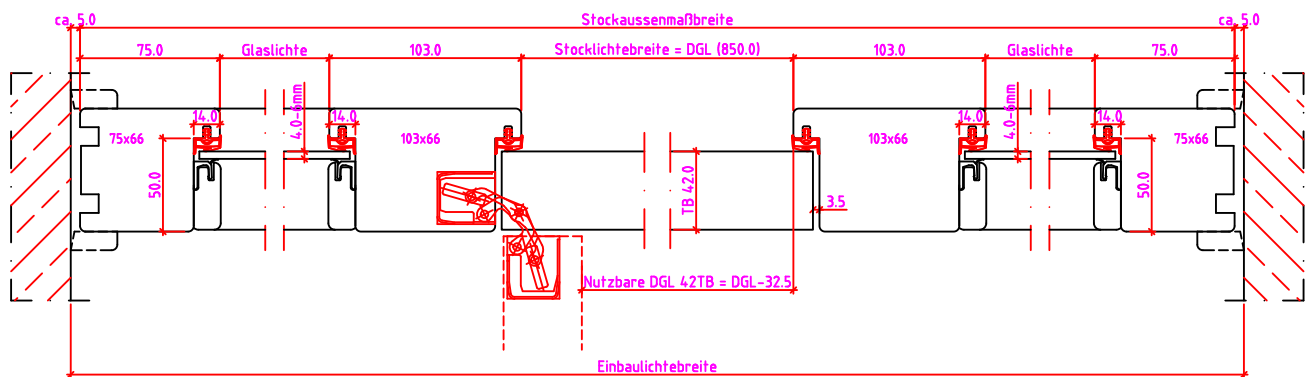
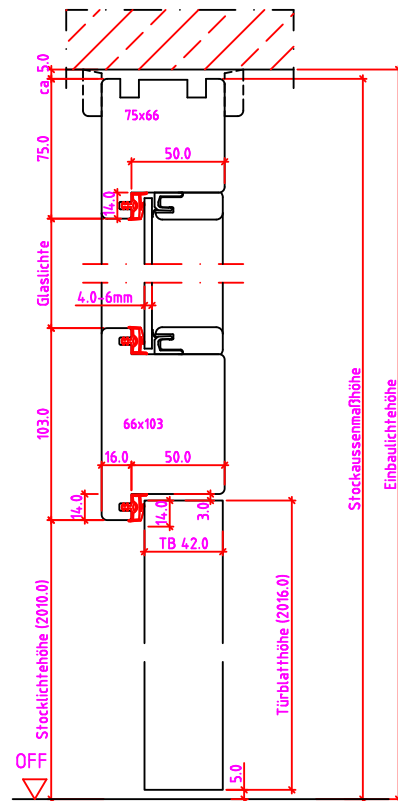

Maßangaben in mm

	Datum	Name	Objekt:	Maßstab:	 <p>Jeld-Wen Türen GmbH A-4582 Spital am Pyhrn</p>
Gez.:	10.12.14	agro	Kunde/Lieferant:		
Gepr.:	..		AB-Nr.:		
Benennung:	Nutzbare DGL RST1 75/66 Modul mit Türblatt 42mm und TE340 Band			Zeichnungs-Nr. 00694975 / A	
Bemerkungen:				Ersatz für:	Alle Rechte vorbehalten

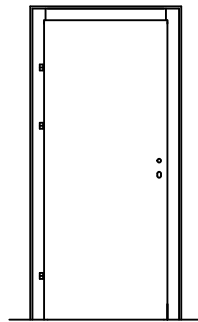

Anschlag links

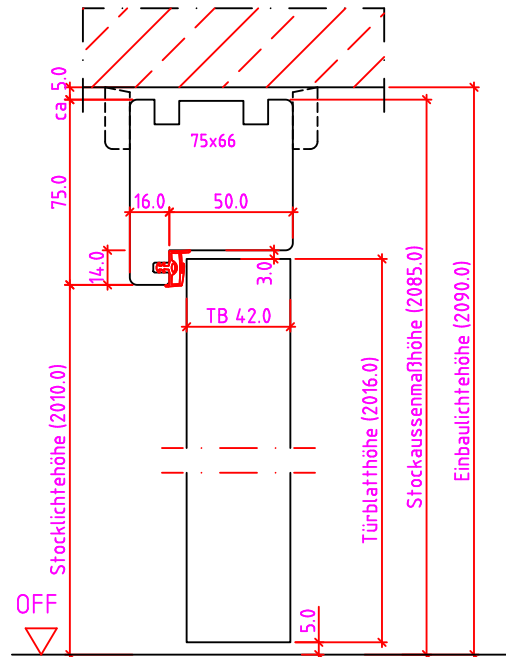

40mm Winkelschiene

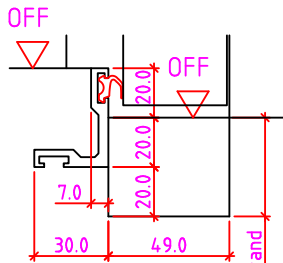

40.0 Bodeneinstand

30mm Winkelschiene

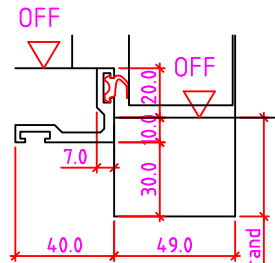

40.0 Bodeneinstand

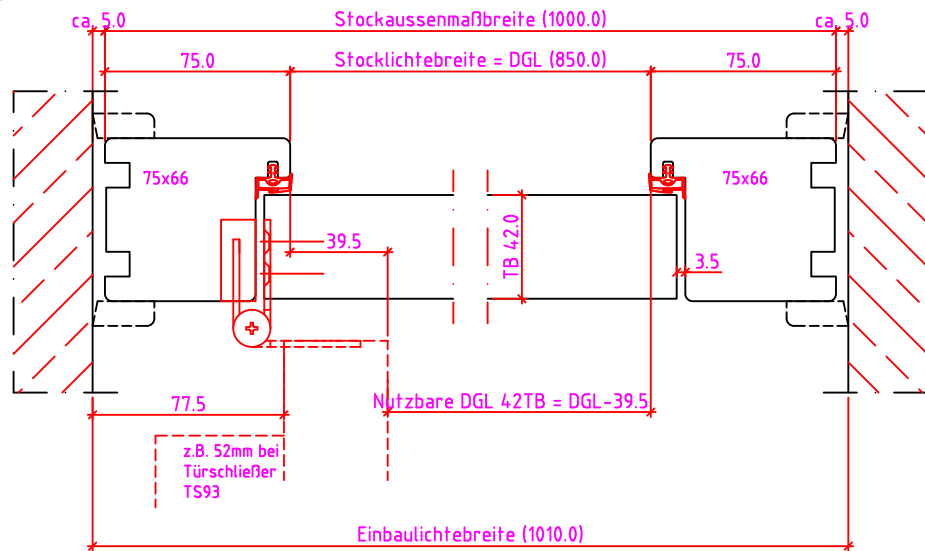

Maßangaben in mm

	Datum	Name	Objekt:	Maßstab:	 <p>Jeld-Wen Türen GmbH A-4582 Spital am Pyhrn</p>
Gez.:	10.12.14	agro	Kunde/Lieferant:		
Gepr.:	.	.	AB-Nr.:		
Benennung:	Nutzbare DGL RSTI 75/66 Modul mit Türblatt 42mm Band V7888 und Bodeneinstand 40mm			Zeichnungs-Nr.	00694975 / A
Bemerkungen:				Ersatz für:	Alle Rechte vorbehalten

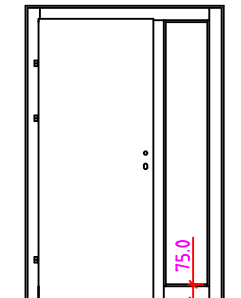

RST 1S-R Anschlag links

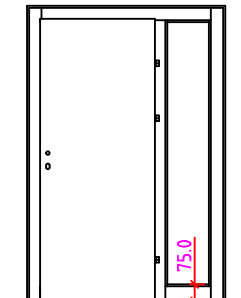

RST 1S-R Anschlag rechts

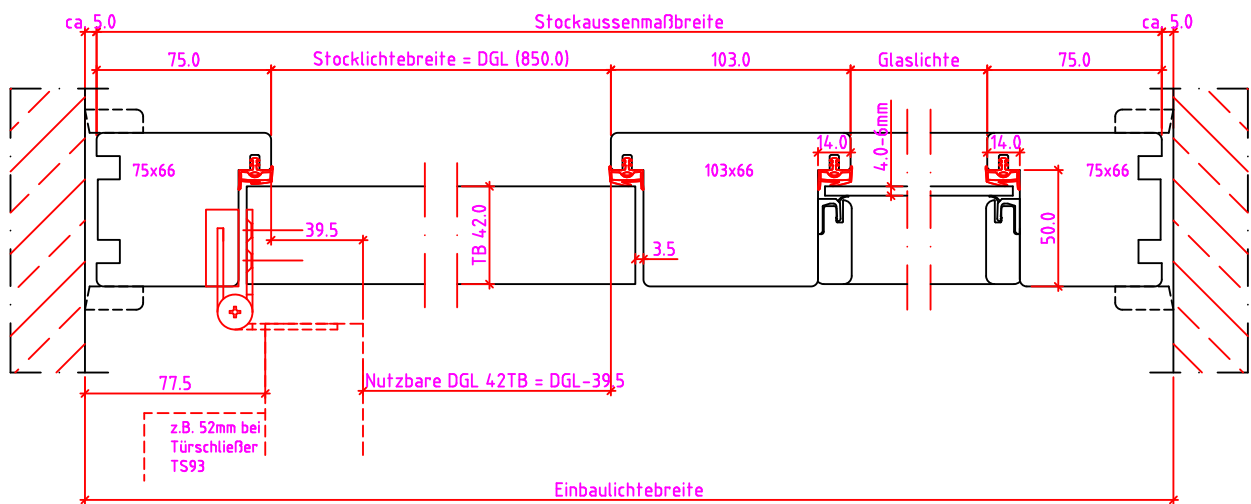
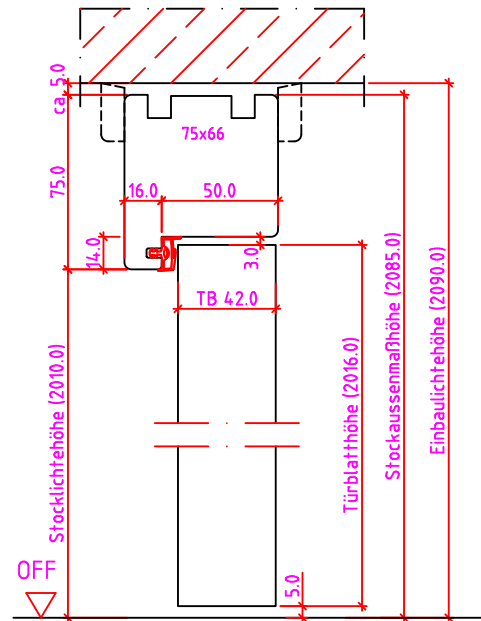

Maßangaben in mm

	Datum	Name	Objekt:	Maßstab:	 <p>Jeld-Wen Türen GmbH A-4582 Spital am Pyhrn</p>
Gez.:	10.12.14	agro	Kunde/Lieferant:		
Gepr.:			AB-Nr.:		
Benennung:	Nutzbare DGL RSTI 75/66 Modul mit Türblatt 42mm Band V7888			Zeichnungs-Nr. 00694975 / A	
Bemerkungen:				Ersatz für:	Alle Rechte vorbehalten

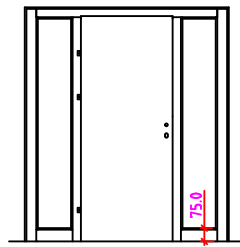

RST 2S Anschlag links

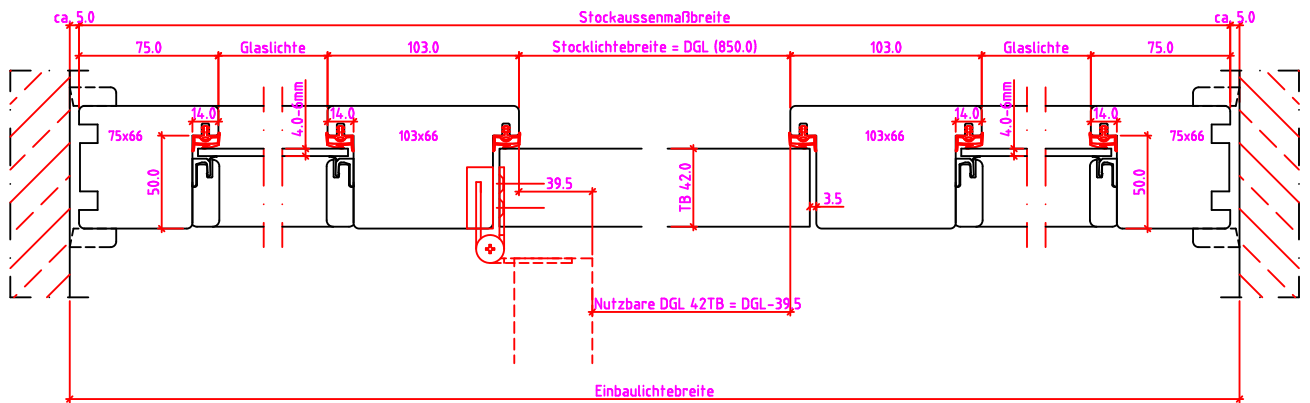
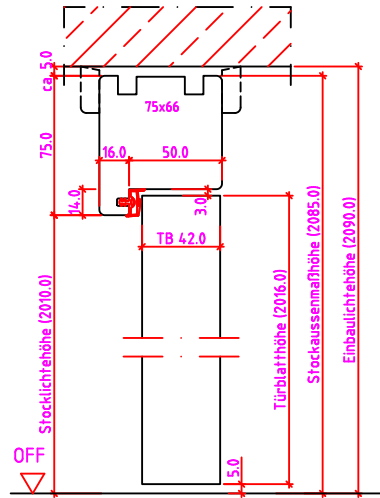

Maßangaben in mm

	Datum	Name	Objekt:	Maßstab:	 <p>Jeld-Wen Türen GmbH A-4582 Spital am Pyhrn</p>
Gez.:	10.12.14	agro	Kunde/Lieferant:		
Gepr.:	.	.	AB-Nr.:		
Benennung:	Nutzbare DGL RST1 75/66 Modul mit Türblatt 42mm Band V7888			Zeichnungs-Nr. 00694975 / A	
Bemerkungen:				Ersatz für:	Alle Rechte vorbehalten

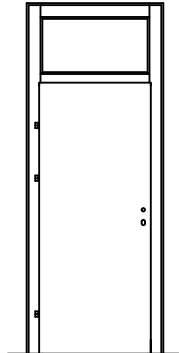

RST-K Anschlag links

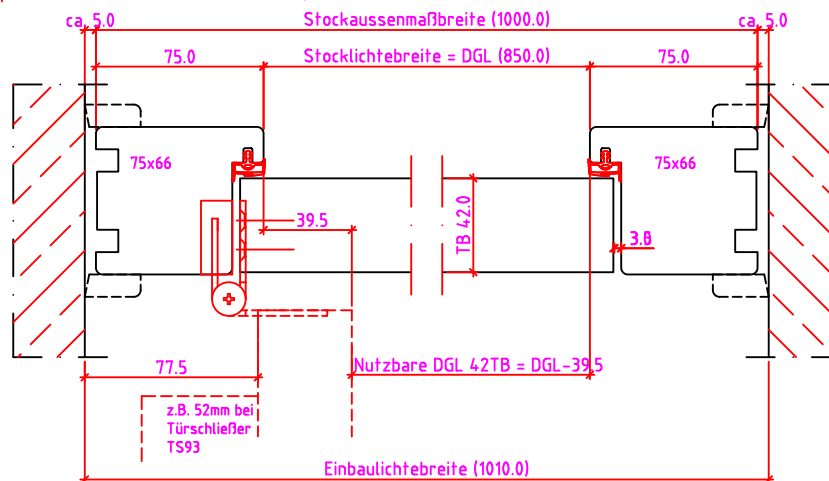
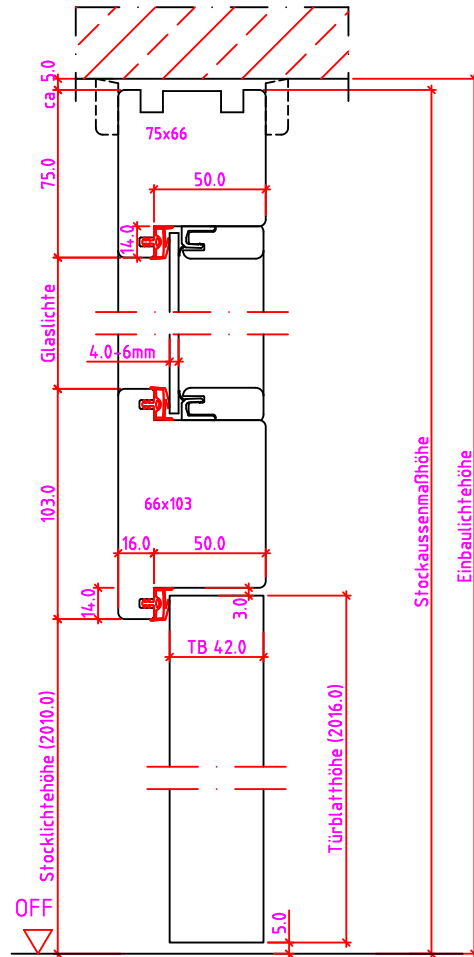
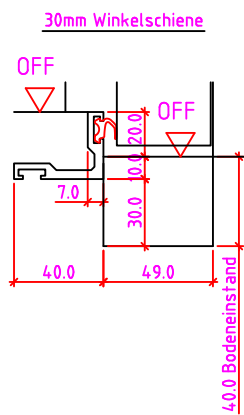
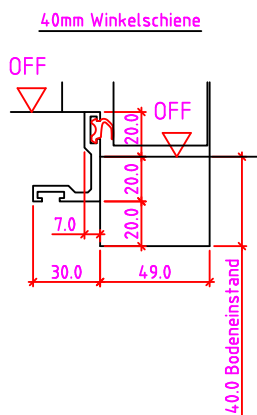

Maßangaben in mm

	Datum	Name	Objekt:	Maßstab:	 <p>Jeld-Wen Türen GmbH A-4582 Spital am Pyhrn</p>
Gez.:	10.12.14	agro	Kunde/Lieferant:		
Gepr.:			AB-Nr.:		
Benennung:	Nutzbare DGL RST1 75/66 Modul mit Türblatt 42mm Band V7888 und Bodeneinstand 40mm			Zeichnungs-Nr.	00694975 / A
Bemerkungen:				Ersatz für:	Alle Rechte vorbehalten

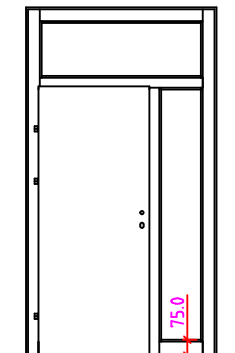

RST 1SK-R Anschlag links

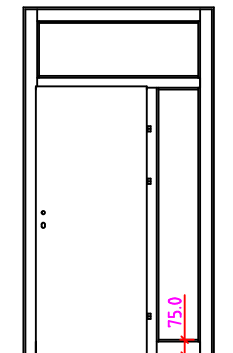

RST 1SK-R Anschlag rechts

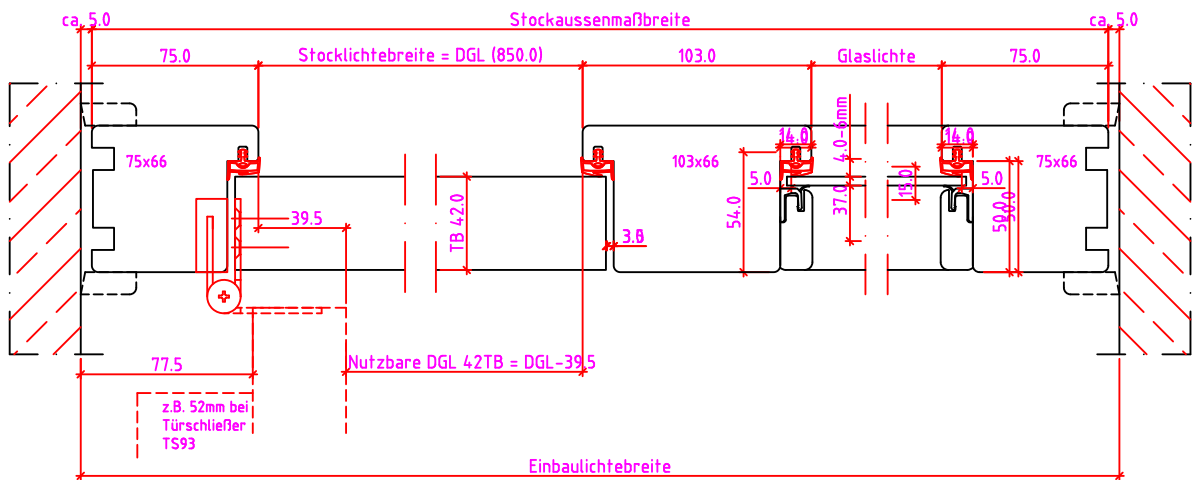
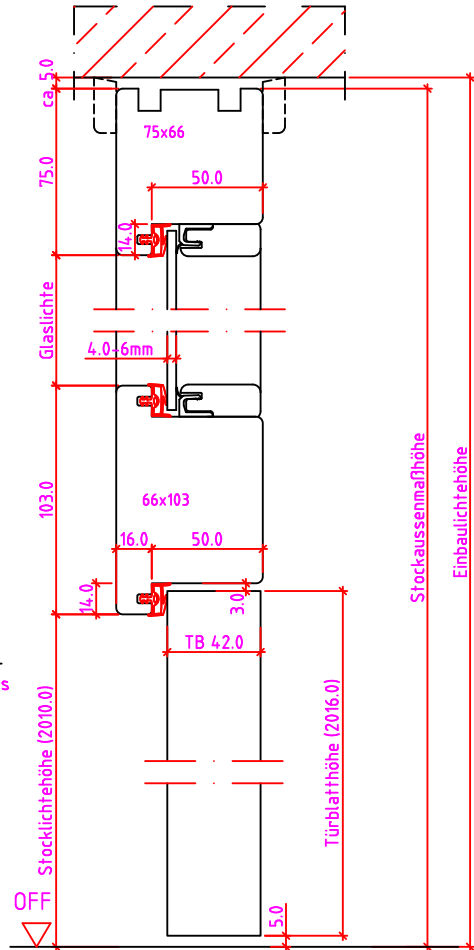

Maßangaben in mm

	Datum	Name	Objekt:	Maßstab:	<p>Jeld-Wen Türen GmbH A-4582 Spital am Pyhrn</p>
Gez.:	10.12.14	agro	Kunde/Lieferant:		
Gepr.:			AB-Nr.:		
Benennung:	Nutzbare DGL RST1 75/66 Modul mit Türblatt 42mm Band V7888			Zeichnungs-Nr. 00694975 / A	
Bemerkungen:				Ersatz für:	Alle Rechte vorbehalten

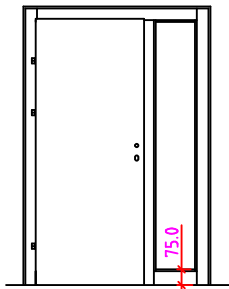

RST 1S-R Anschlag links

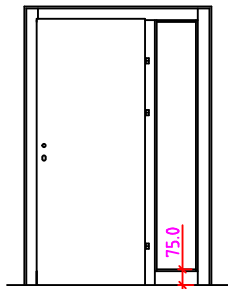

RST 1S-R Anschlag rechts

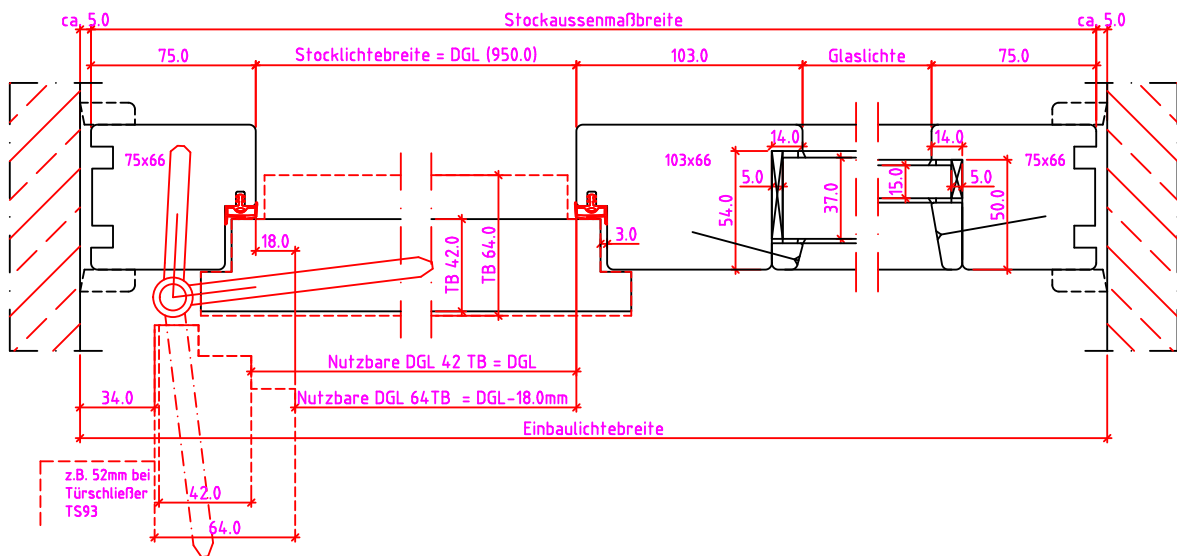
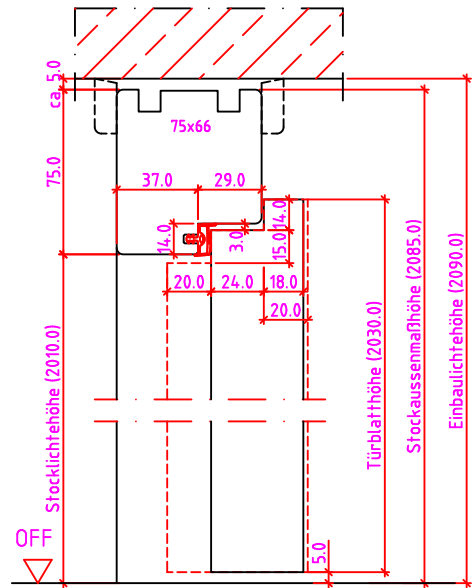

Maßangaben in mm

	Datum	Name	Objekt:	Maßstab:	 <p>Jeld-Wen Türen GmbH A-4582 Spital am Pyhrn</p>
Gez.:	21.11.14	agro	Kunde/Lieferant:		
Gepr.:			AB-Nr.:		
Benennung:	Nutzbare DGL RSTA 75/66 gefälzt (EI30) mit Türblatt 42 und 64mm und 18er Band			Zeichnungs-Nr. 00691366 / A	
Bemerkungen:				Ersatz für:	Alle Rechte vorbehalten

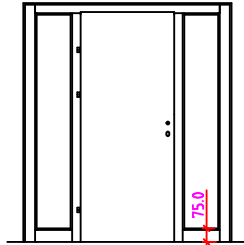

RST 2S Anschlag links

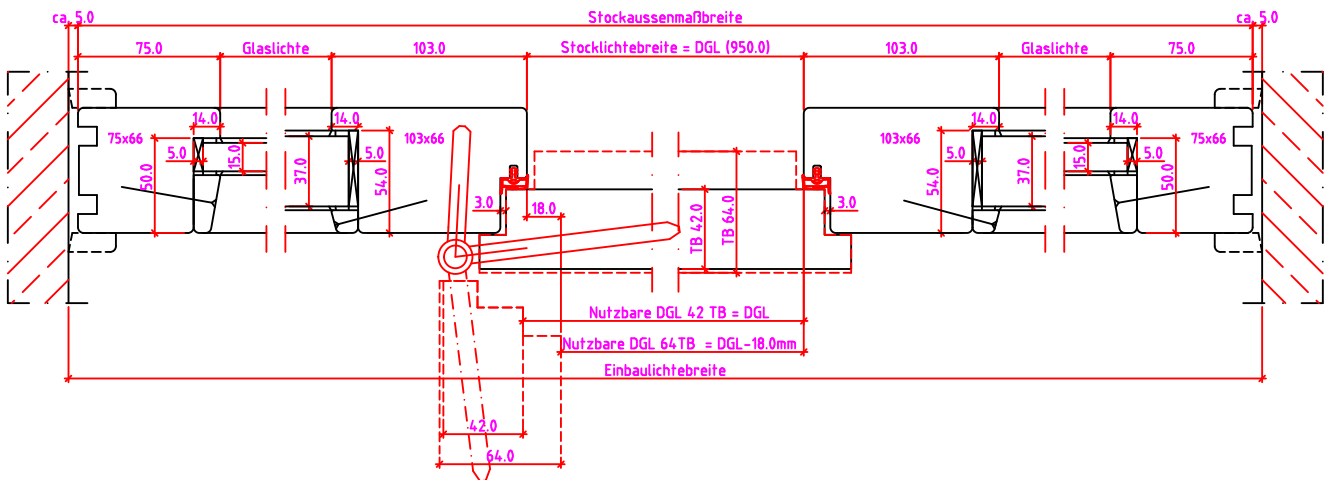
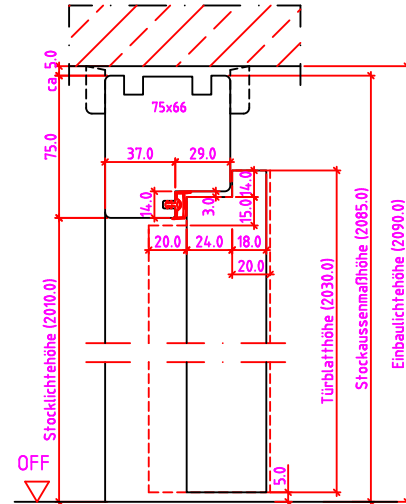

Maßangaben in mm

	Datum	Name	Objekt:	Maßstab:	 <p>Jeld-Wen Türen GmbH A-4582 Spital am Pyhrn</p>
Gez.:	21.11.14	agro	Kunde/Lieferant:		
Gepr.:	..		AB-Nr.:		
Benennung:	Nutzbare DGL RSTA 75/66 gefälzt (EI30) mit Türblatt 42 und 64mm und 18er Band			Zeichnungs-Nr.	00691366 / A
Bemerkungen:				Ersatz für:	Alle Rechte vorbehalten

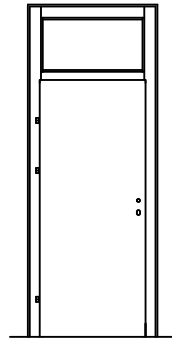

RST-K Anschlag links

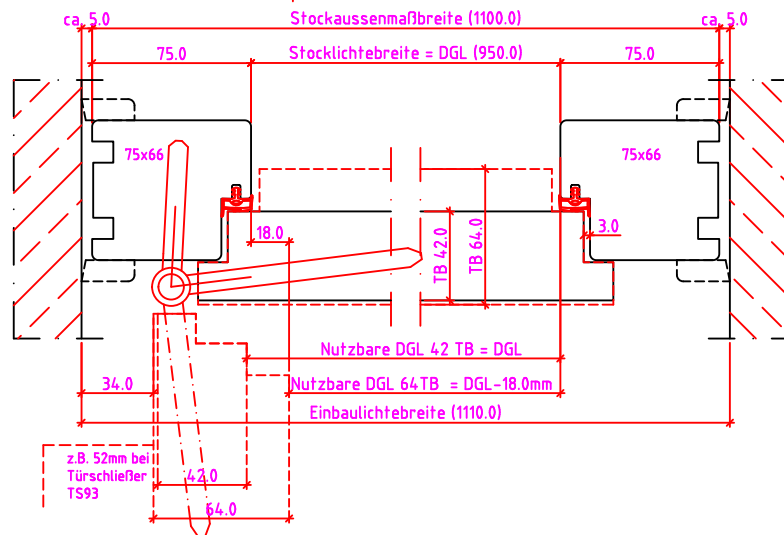
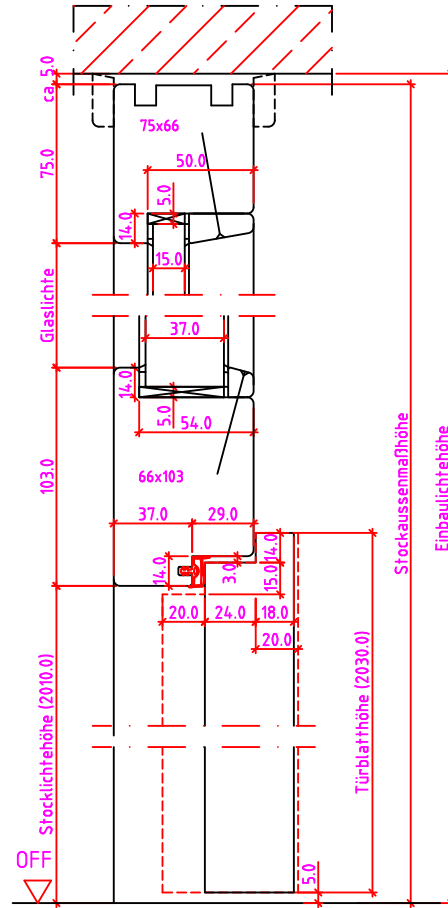
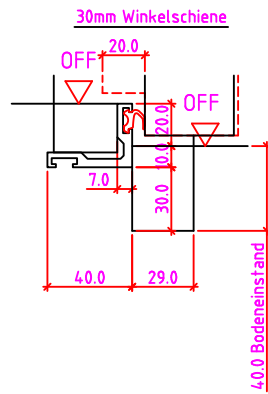
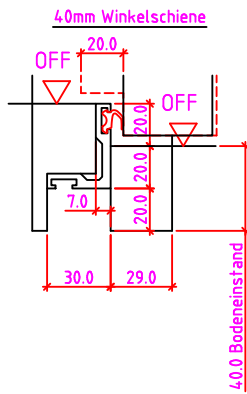

Maßangaben in mm

	Datum	Name	Objekt:	Maßstab:	 <p>Jeld-Wen Türen GmbH A-4582 Spital am Pyhrn</p>
Gez.:	21.11.14	agro	Kunde/Lieferant:		
Gepr.:			AB-Nr.:		
Benennung:	Nutzbare DGL RSTA 75/66 gefälzt (EI30) mit Türblatt 42 und 64mm mit 18er Band Winkelschiene und Bodeneinstand 40mm			Zeichnungs-Nr. 00691366 / A	
Bemerkungen:				Ersatz für:	Alle Rechte vorbehalten

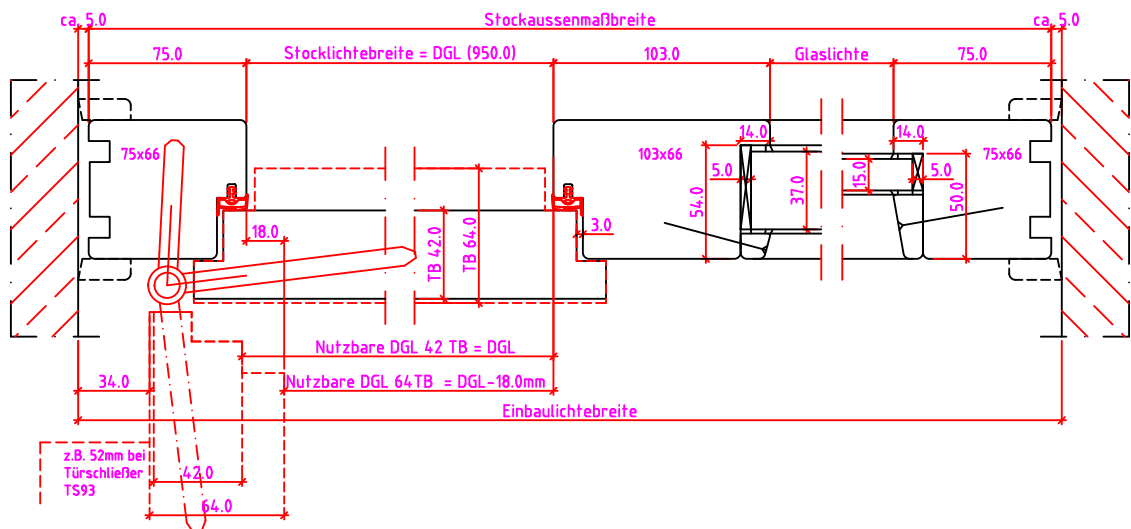
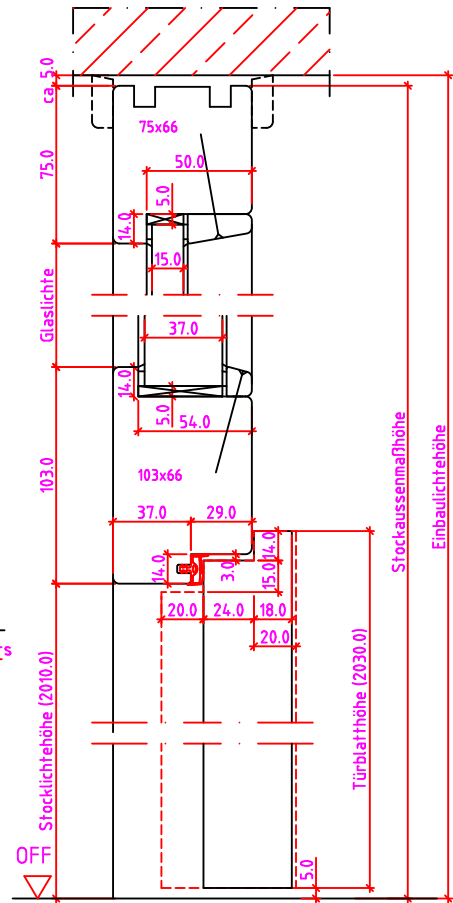

Maßangaben in mm

	Datum	Name	Objekt:	Maßstab:	 <p>Jeld-Wen Türen GmbH A-4582 Spital am Pyhrn</p>
Gez.:	21.11.14	agro	Kunde/Lieferant:		
Gepr.:			AB-Nr.:		
Benennung:	Nutzbare DGL RSTA 75/66 gefälzt (EI30) mit Türblatt 42 und 64mm und 18er Band			Zeichnungs-Nr. 00691366 / A	
Bemerkungen:				Ersatz für:	Alle Rechte vorbehalten

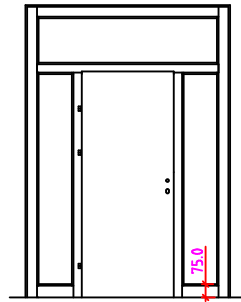

RST 2SK Anschlag links

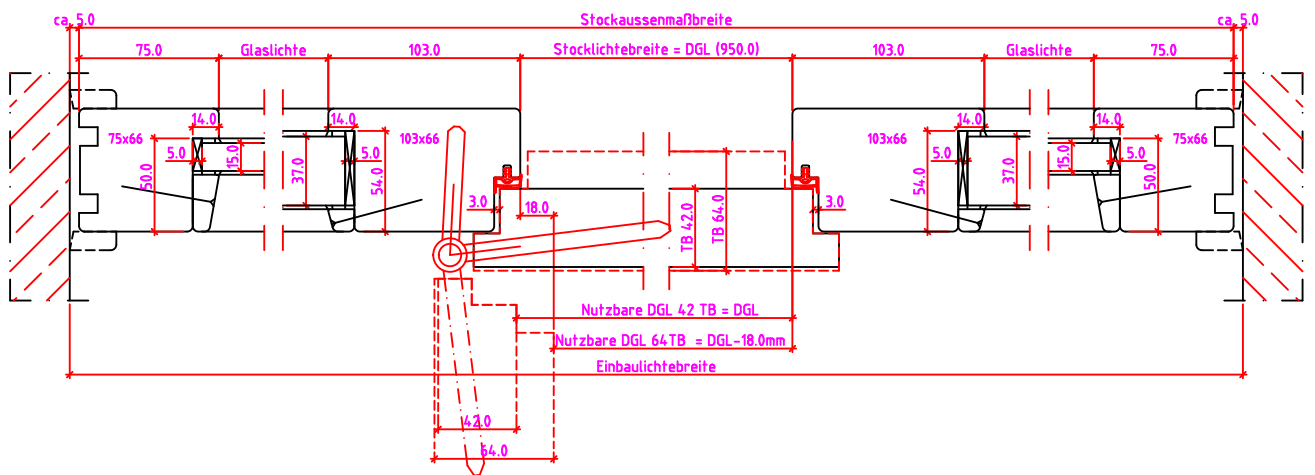
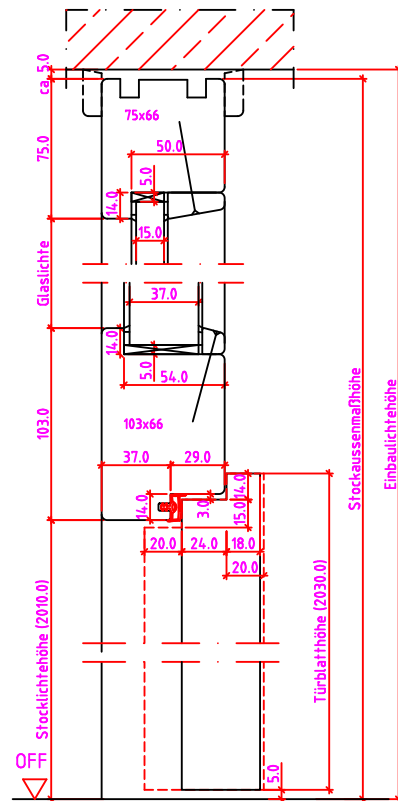

Maßangaben in mm

	Datum	Name	Objekt:	Maßstab:	 <p>Jeld-Wen Türen GmbH A-4582 Spital am Pyhrn</p>
Gez.:	21.11.14	agro	Kunde/Lieferant:		
Gepr.:	..		AB-Nr.:		
Benennung:	Nutzbare DGL RSTA 75/66 gefälzt (EI30) mit Türblatt 42 und 64mm und 18er Band			Zeichnungs-Nr.	00691366 / A
Bemerkungen:				Ersatz für:	Alle Rechte vorbehalten

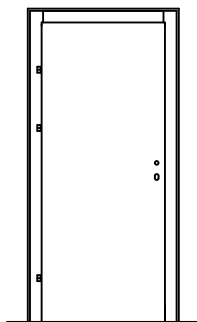

Anschlag links

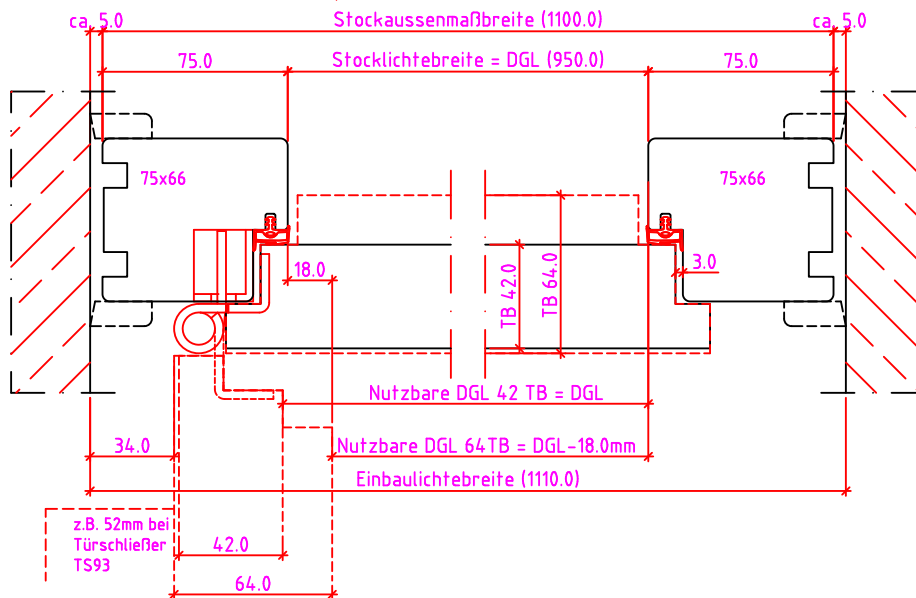
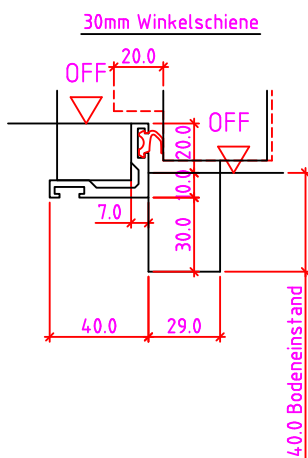
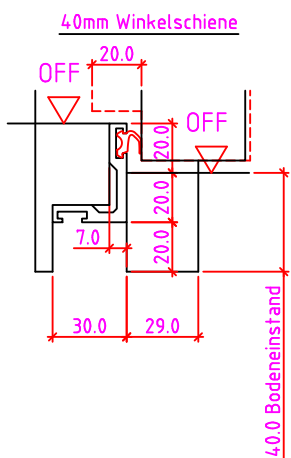
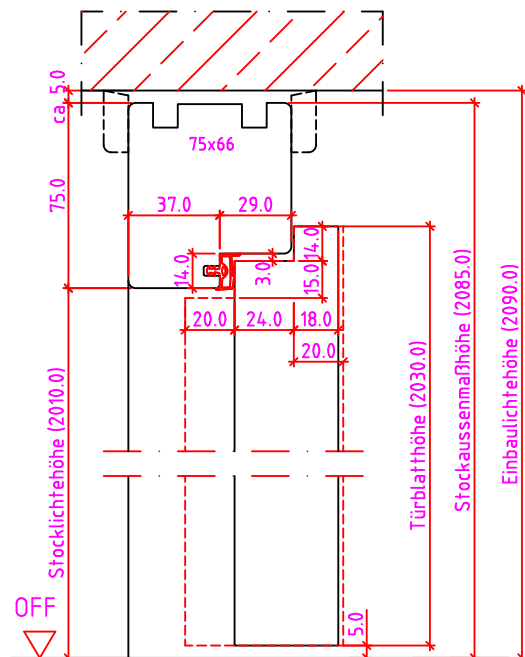

Maßangaben in mm

	Datum	Name	Objekt:	Maßstab:	 <p>Jeld-Wen Türen GmbH A-4582 Spital am Pyhrn</p>
Gez.:	21.11.14	agro	Kunde/Lieferant:		
Gepr.:			AB-Nr.:		
Benennung:	Nutzbare DGL RSTA 75/66 gefälzt (EI30) mit Türblatt 42 und 64mm Band VX7939 Winkelschiene und Bodeneinstand 4.0mm			Zeichnungs-Nr. 00691366 / A	
Bemerkungen:				Ersatz für:	Alle Rechte vorbehalten

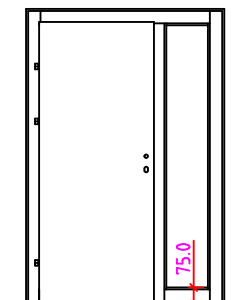

RST 1S-R Anschlag links

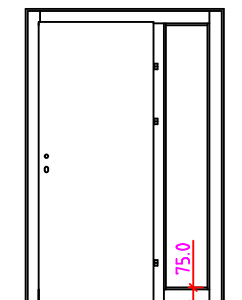

RST 1S-R Anschlag rechts

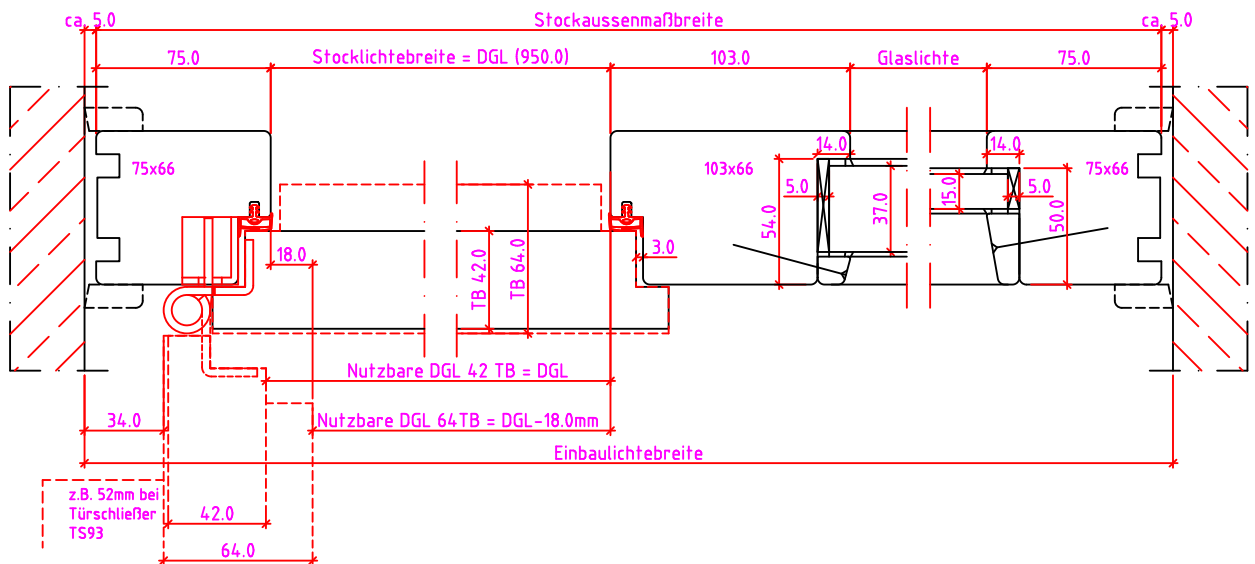
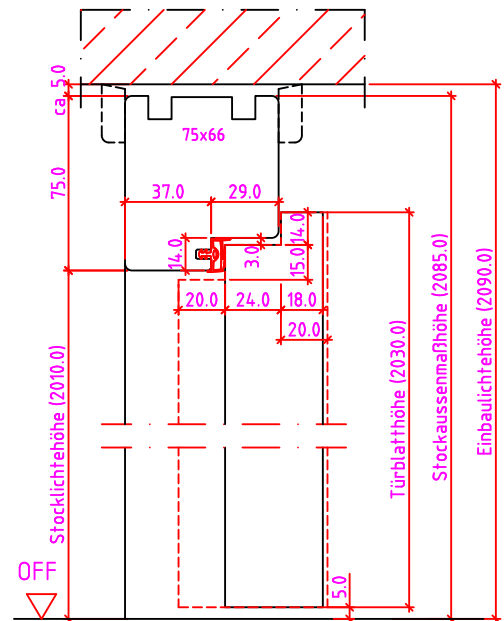

Maßangaben in mm

	Datum	Name	Objekt:	Maßstab:	 <p>Jeld-Wen Türen GmbH A-4582 Spital am Pyhrn</p>
Gez.:	21.11.14	agro	Kunde/Lieferant:		
Gepr.:	.	.	AB-Nr.:		
Benennung:	Nutzbare DGL RSTA 75/66 gefälzt (EI30) mit Türblatt 42 und 64mm Band VX7939			Zeichnungs-Nr. 00691366 / A	
Bemerkungen:				Ersatz für:	Alle Rechte vorbehalten

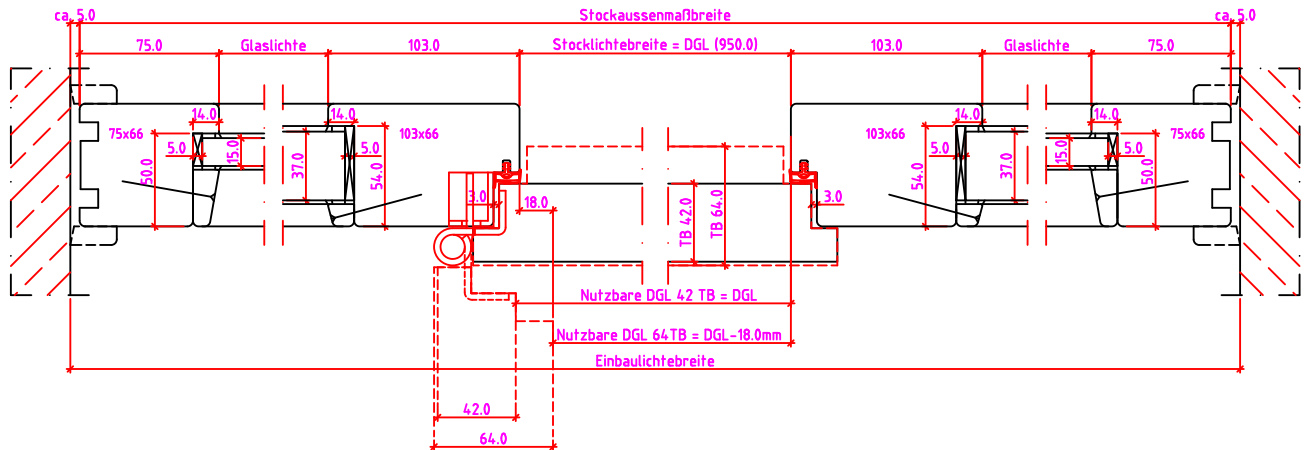
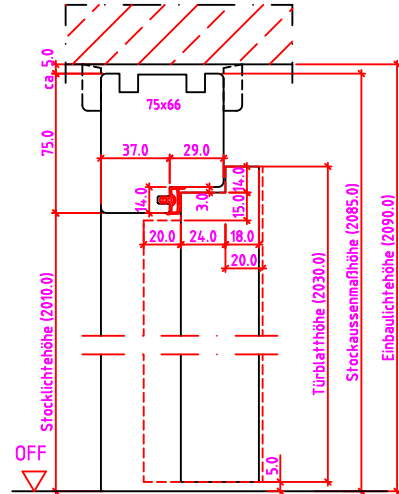
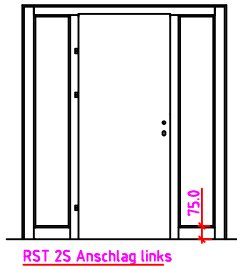

Maßangaben in mm

	Datum	Name	Objekt:	Maßstab:	 <p>Jeld-Wen Türen GmbH A-4582 Spital am Pyhrn</p>
Gez.:	21.11.14	agro	Kunde/Lieferant:		
Gepr.:	.		AB-Nr.:		
Benennung:	Nutzbare DGL RSTA 75/66 gefälzt (EI30) mit Türblatt 42 und 64mm Band VX7939 Winkelschne und Bodeneinstand 40mm			Zeichnungs-Nr. 00691366 / A	
Bemerkungen:				Ersatz für:	Alle Rechte vorbehalten

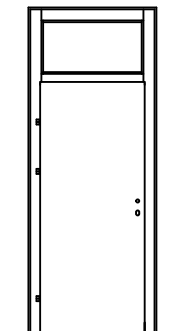

RST-K Anschlag links

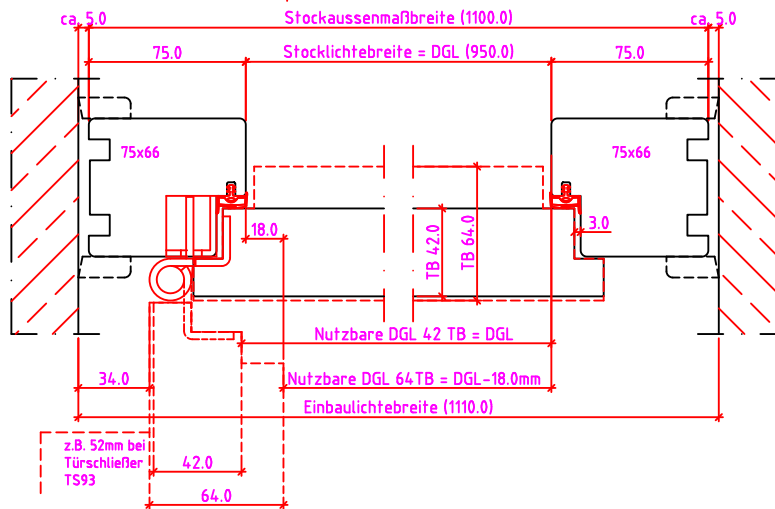
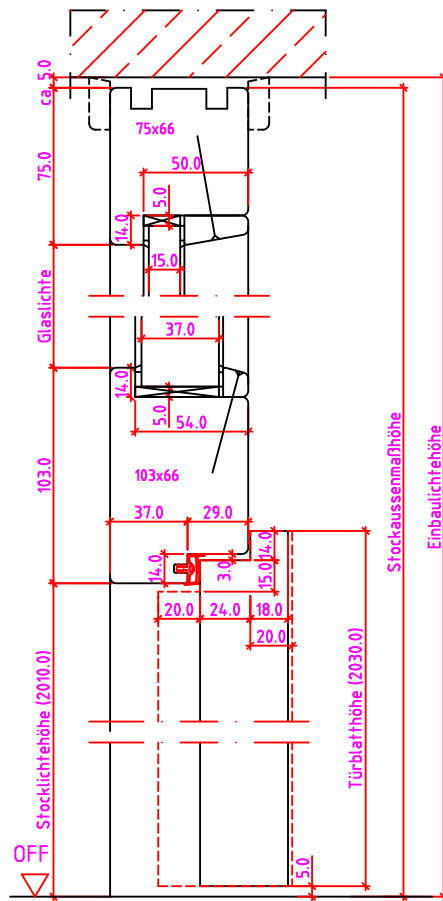
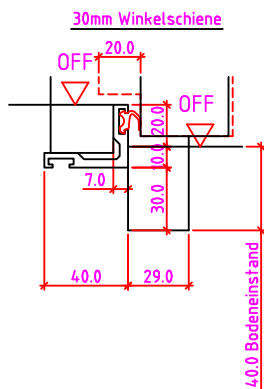
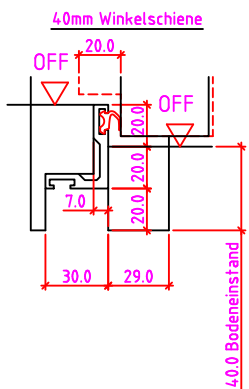

Maßangaben in mm

	Datum	Name	Objekt:	Maßstab:
Gez.:	21.11.14	agro	Kunde/Lieferant:	
Gepr.:			AB-Nr.:	
Benennung:	Nutzbare DGL RSTA 75/66 gefälzt (EI30) mit Türblatt 42 und 64mm Band VX7939 Winkelschiene und Bodeneinstand 4.0mm			Zeichnungs-Nr. 00691366 / A
Bemerkungen:				Ersatz für:



Jeld-Wen Türen GmbH
A-4582 Spital am Pyhrn

Alle Rechte vorbehalten

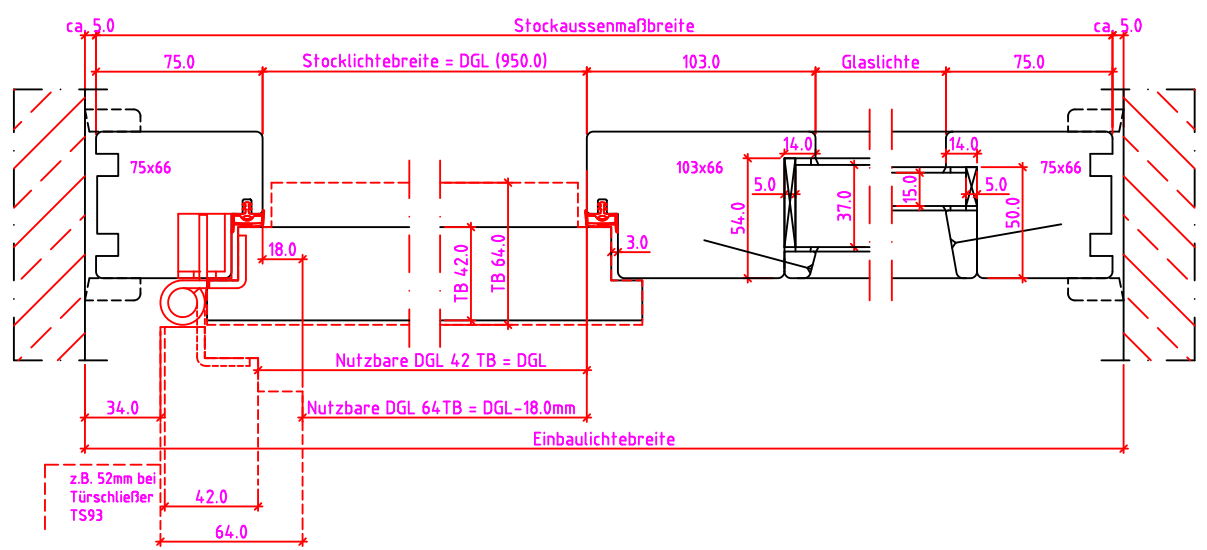
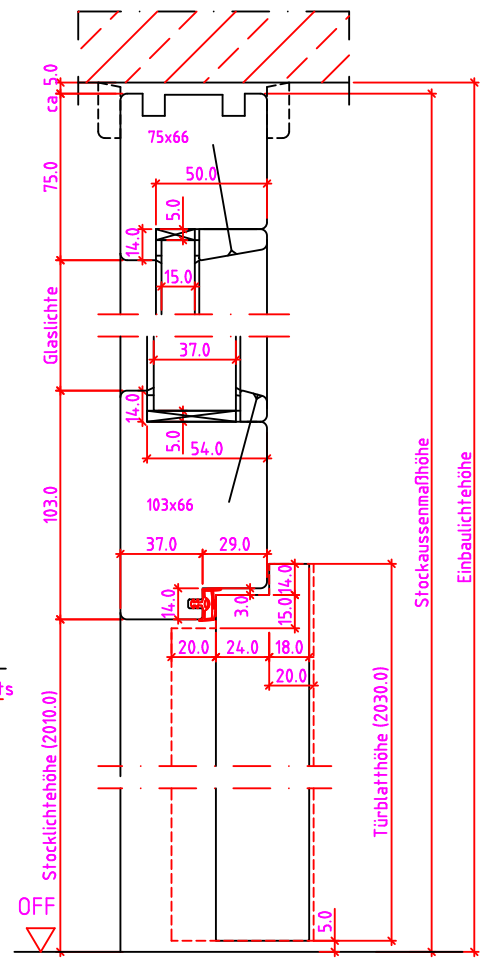

Maßangaben in mm

	Datum	Name	Objekt:	Maßstab:
Gez.:	21.11.14	agro	Kunde/Lieferant:	
Gepr.:			AB-Nr.:	
Benennung:	Nutzbare DGL RSTA 75/66 gefälzt (EI30) mit Türblatt 42 und 64mm Band VX7939			Zeichnungs-Nr. 00691366 / A
Bemerkungen:				Ersatz für:

DANA®

Jeld-Wen Türen GmbH
A-4582 Spital am Pyhrn

Alle Rechte vorbehalten

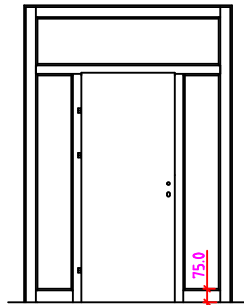

RST 2SK Anschlag links

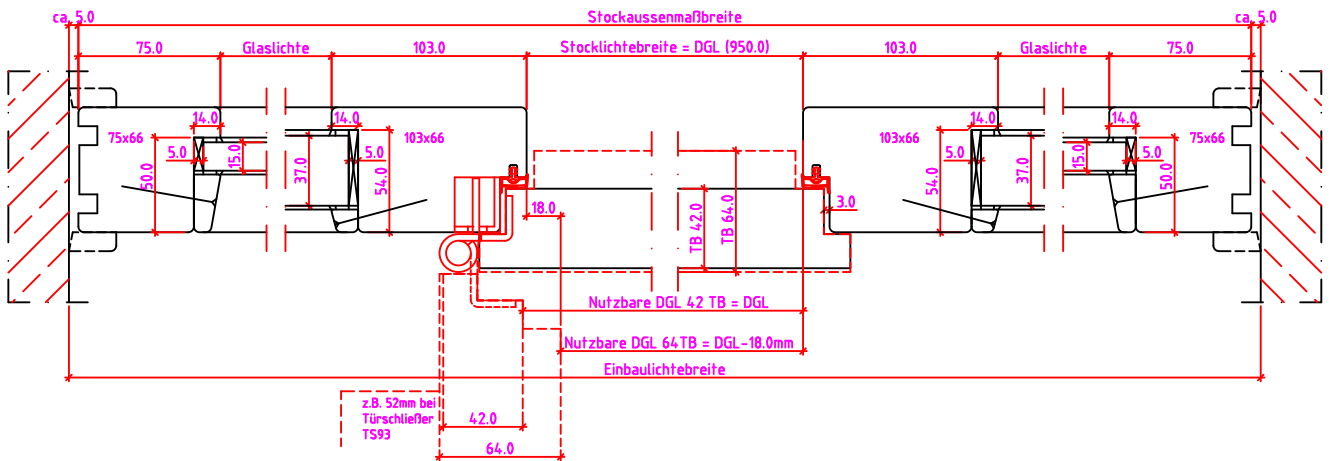
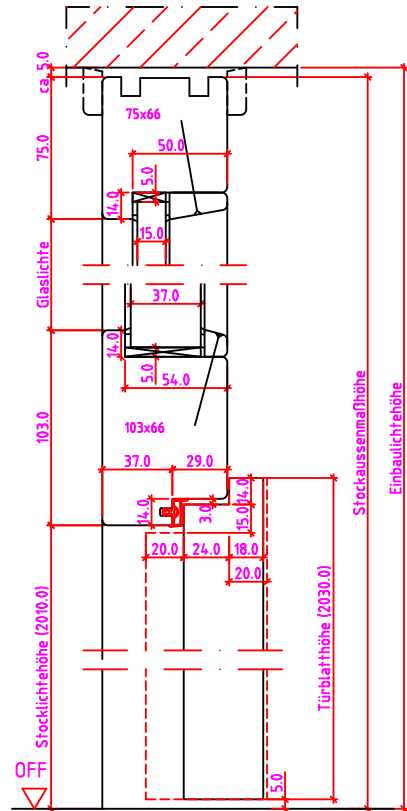

Maßangaben in mm

	Datum	Name	Objekt:	Maßstab:	 <p>Jeld-Wen Türen GmbH A-4582 Spital am Pyhrn</p>
Gez.:	21.11.14	agro	Kunde/Lieferant:		
Gepr.:	.	.	AB-Nr.:		
Benennung:	Nutzbare DGL RSTA 75/66 gefälzt (EI30) mit Türblatt 42 und 64mm Band VX7939			Zeichnungs-Nr.	00691366 / A
Bemerkungen:				Ersatz für:	Alle Rechte vorbehalten

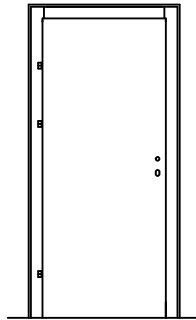

Anschlag links

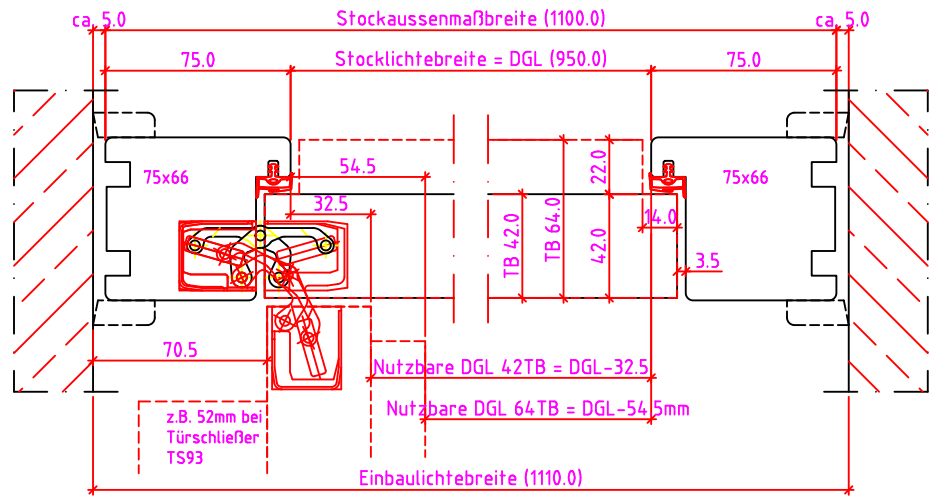
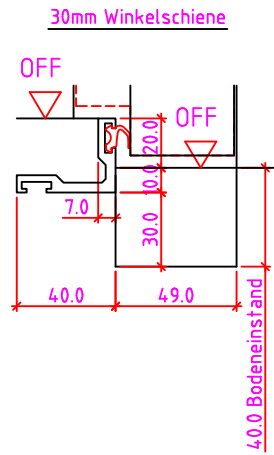
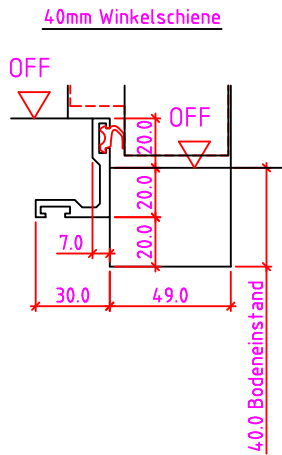
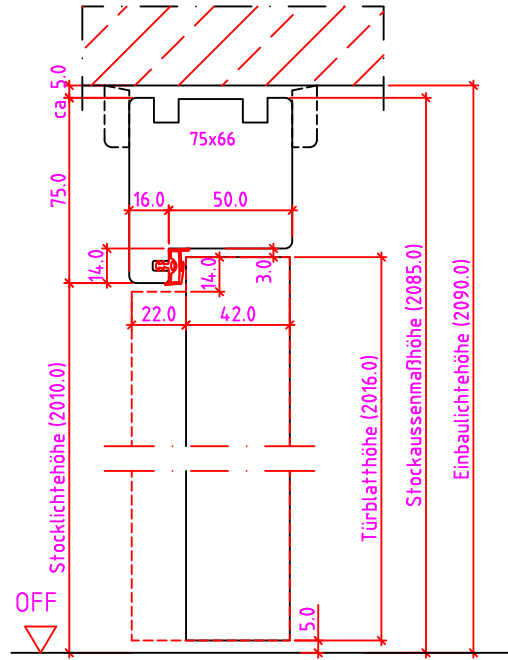

Maßangaben in mm

	Datum	Name	Objekt:	Maßstab:	 <p>Jeld-Wen Türen GmbH A-4582 Spital am Pyhrn</p>
Gez.:	10.12.14	agro	Kunde/Lieferant:		
Gepr.:			AB-Nr.:		
Benennung:	Nutzbare DGL RSTA 75/66 Modul (E130) mit Türblatt 42 und 64mm mit TE340 und Bodeneinstand 40mm			Zeichnungs-Nr. 00693080 / A	
Bemerkungen:				Ersatz für:	Alle Rechte vorbehalten

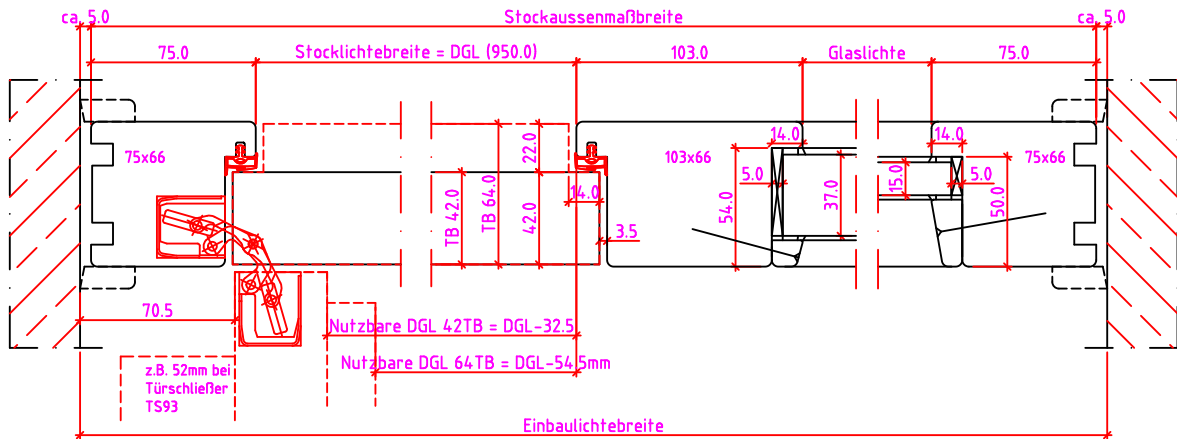
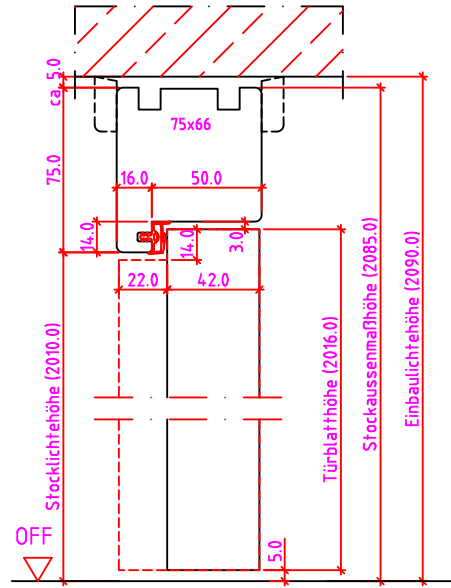
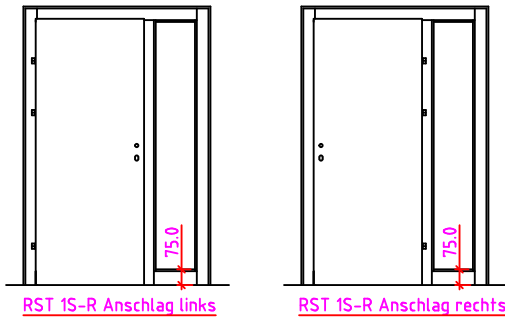

Maßangaben in mm

	Datum	Name	Objekt:	Maßstab:	 <p>Jeld-Wen Türen GmbH A-4582 Spital am Pyhrn</p>
Gez.:	10.12.14	agro	Kunde/Lieferant:		
Gepr.:	.	.	AB-Nr.:		
Benennung:	Nutzbare DGL RSTA 75/66 Modul (E130) mit Türblatt 42 und 64mm und TE340 Band			Zeichnungs-Nr. 00693080 / A	
Bemerkungen:				Ersatz für:	Alle Rechte vorbehalten

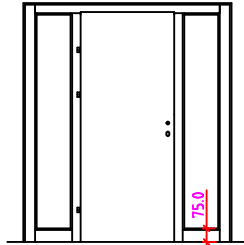

RST 2S Anschlag links

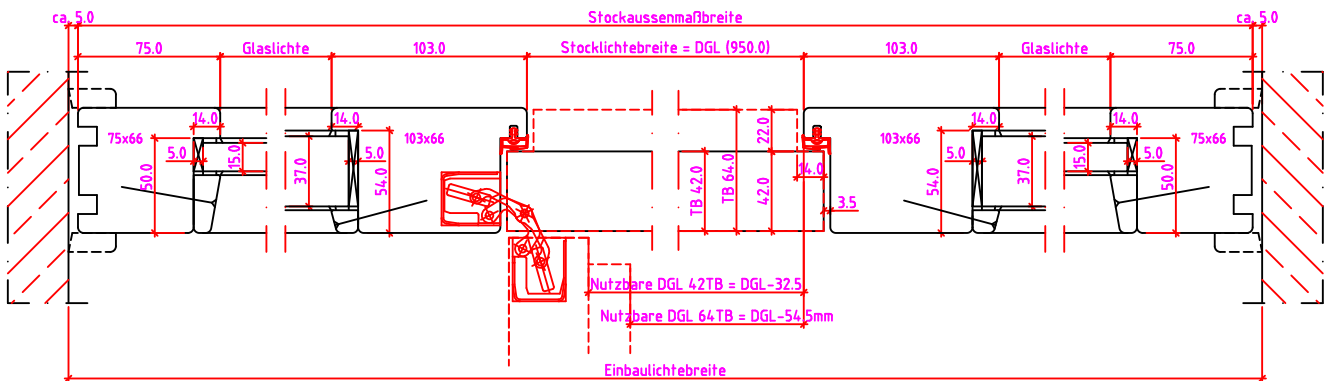
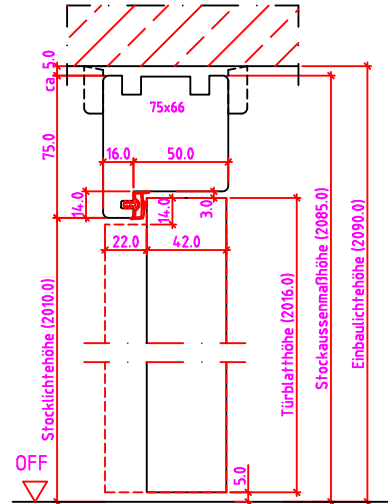

Maßangaben in mm

	Datum	Name	Objekt:	Maßstab:	 <p>Jeld-Wen Türen GmbH A-4582 Spital am Pyhrn</p>
Gez.:	10.12.14	agro	Kunde/Lieferant:		
Gepr.:	.	.	AB-Nr.:		
Benennung:	Nutzbare DGL RSTA 75/66 Modul (E130) mit Türblatt 42 und 64mm und TE340 Band			Zeichnungs-Nr. 00693080 / A	
Bemerkungen:				Ersatz für:	Alle Rechte vorbehalten

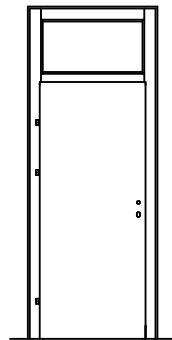

RST-K Anschlag links

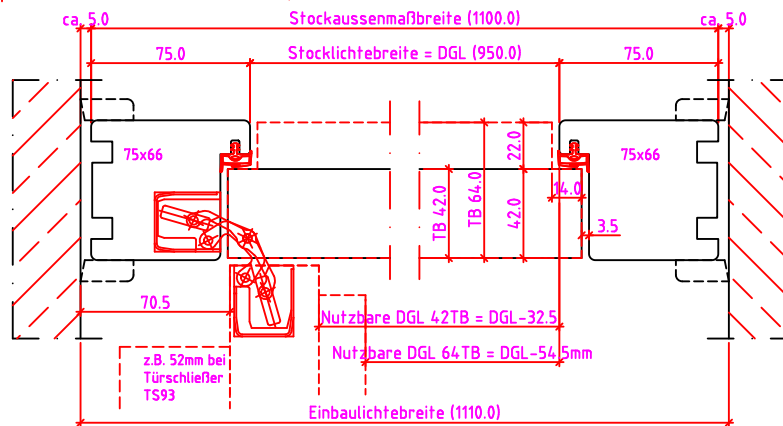
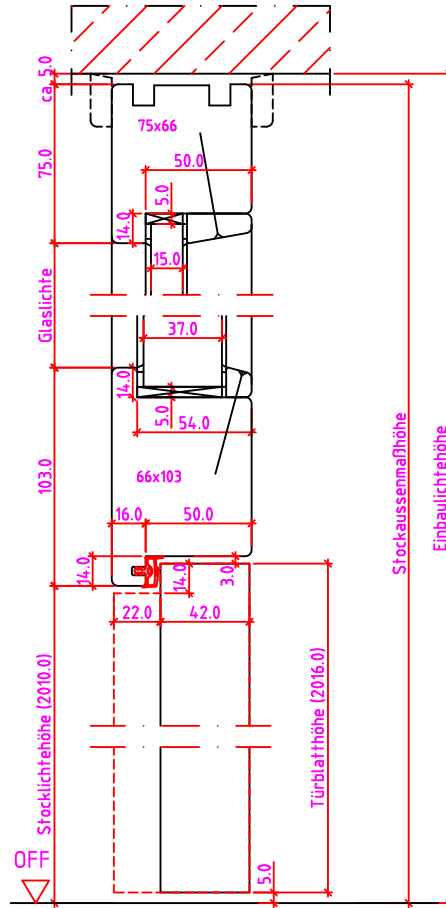
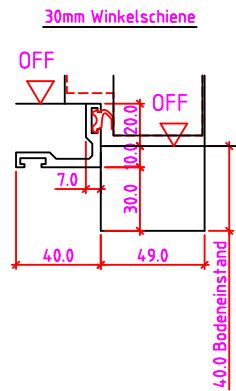
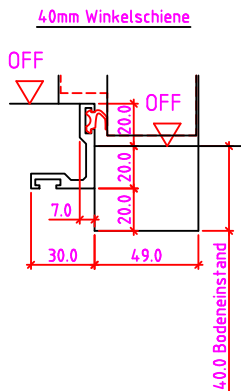

Maßangaben in mm

	Datum	Name	Objekt:	Maßstab:	 <p>Jeld-Wen Türen GmbH A-4582 Spital am Pyhrn</p>
Gez.:	10.12.14	agro	Kunde/Lieferant:		
Gepr.:			AB-Nr.:		
Benennung:	Nutzbare DGL RSTA 75/66 Modul (E130) mit Türblatt 42 und 64mm und TE340 Band			Zeichnungs-Nr. 00693080 / A	
Bemerkungen:				Ersatz für:	Alle Rechte vorbehalten

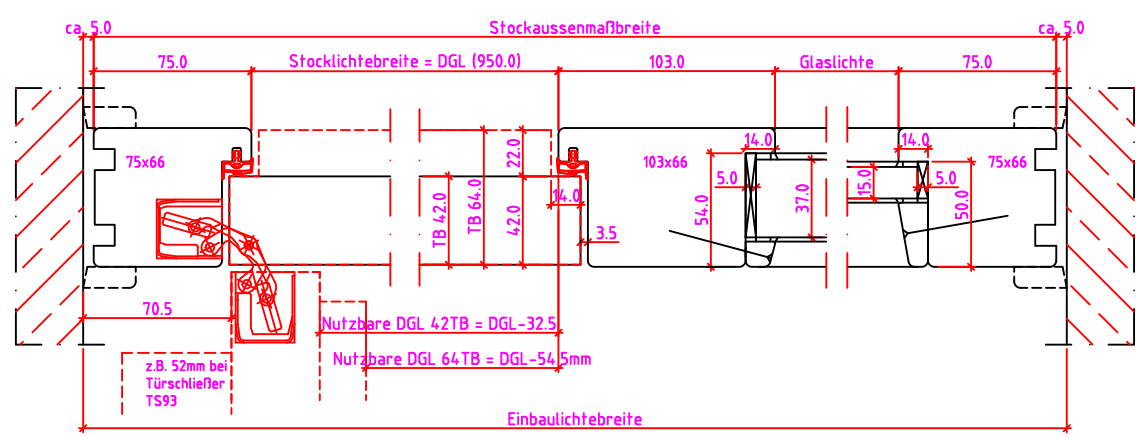
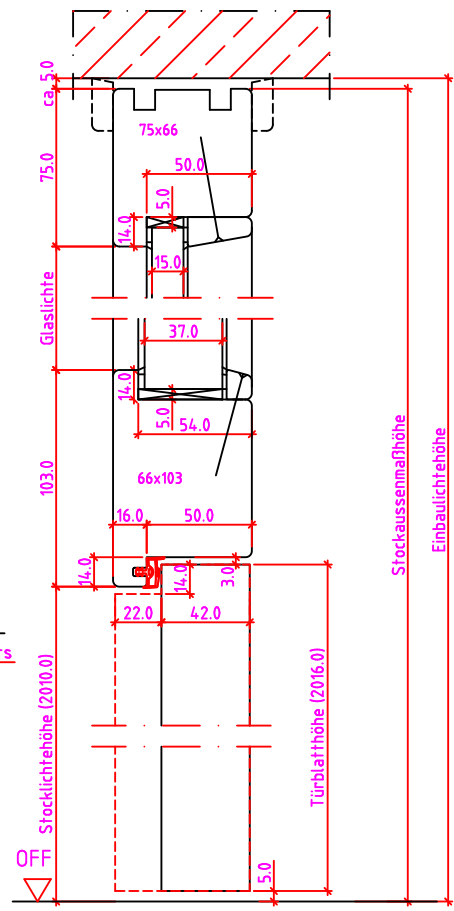

Maßangaben in mm

	Datum	Name	Objekt:	Maßstab:
Gez.:	10.12.14	agro	Kunde/Lieferant:	
Gepr.:	..		AB-Nr.:	
Benennung:	Nutzbare DGL RSTA 75/66 Modul (E130) mit Türblatt 42 und 64mm und TE340 Band			Zeichnungs-Nr. 00693080 / A
Bemerkungen:				Ersatz für:

DANA®

Jeld-Wen Türen GmbH
A-4582 Spital am Pyhrn

Alle Rechte vorbehalten

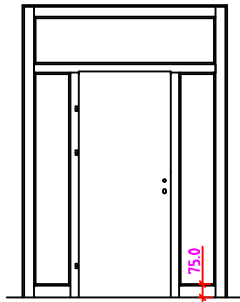

RST 2SK Anschlag links

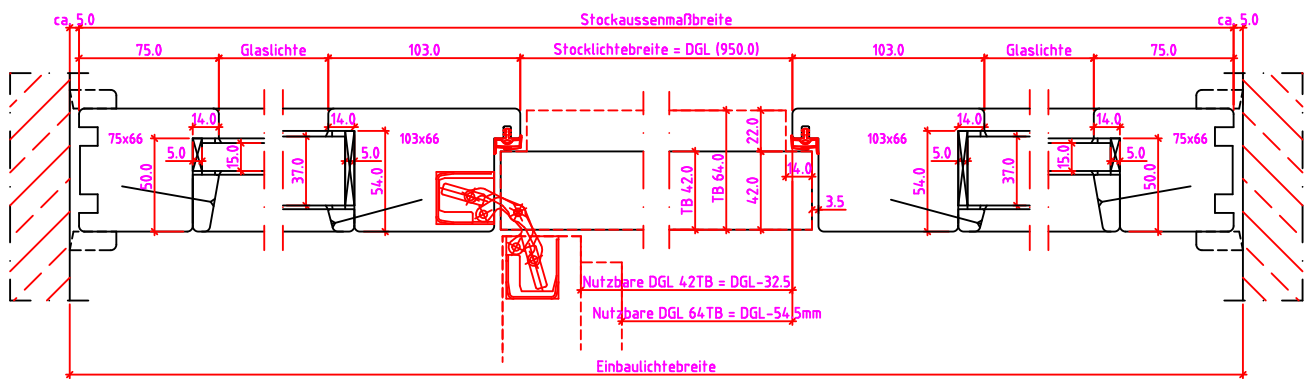
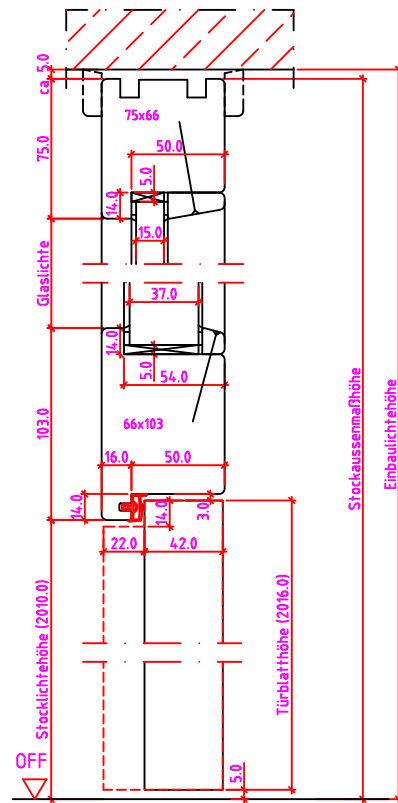

Maßangaben in mm

	Datum	Name	Objekt:	Maßstab:	<p>Jeld-Wen Türen GmbH A-4582 Spital am Pyhrn</p>
Gez.:	10.12.14	agro	Kunde/Lieferant:	<p>00693080 / A</p>	
Gepr.:	..		AB-Nr.:		
Benennung: Nutzbare DGL RSTA 75/66 Modul (E130) mit Türblatt 42 und 64mm und TE340 Band				Zeichnungs-Nr.	
Bemerkungen:				Ersatz für:	
				Alle Rechte vorbehalten	

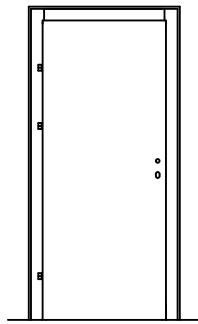

Anschlag links

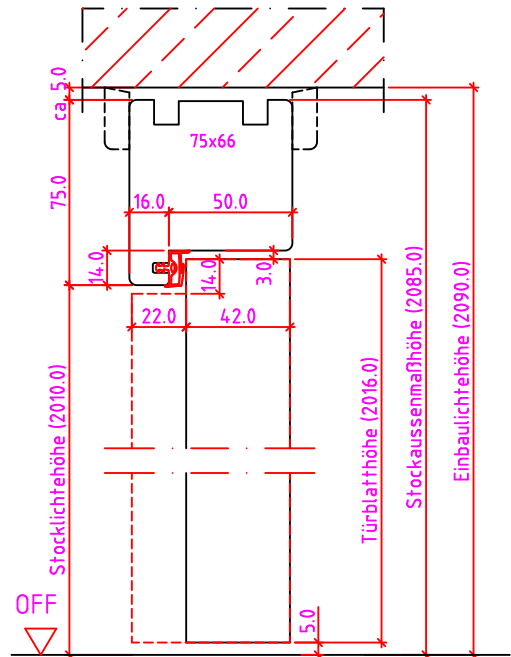

40mm Winkelschiene

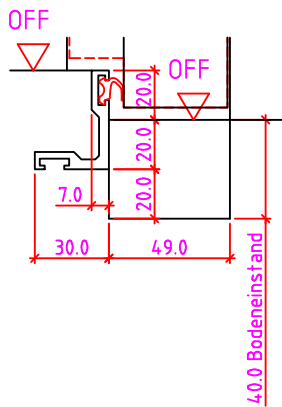

30mm Winkelschiene

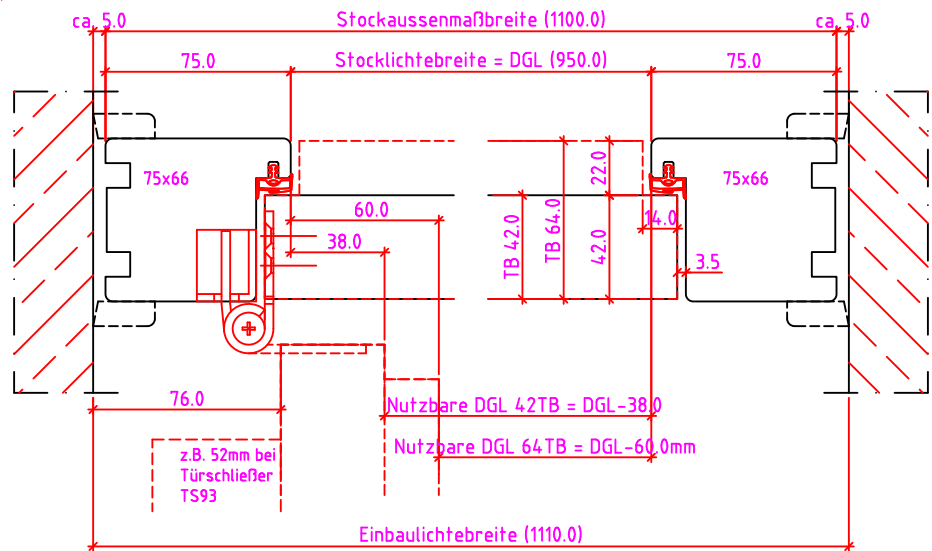
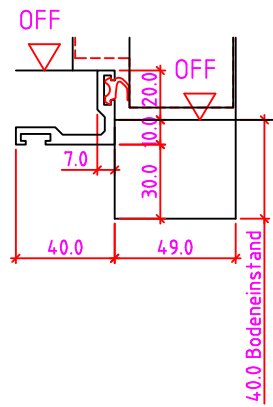

Maßangaben in mm

	Datum	Name	Objekt:	Maßstab:	 <p>Jeld-Wen Türen GmbH A-4582 Spital am Pyhrn</p>
Gez.:	10.12.14	agro	Kunde/Lieferant:	00693080 / A	
Gepr.:			AB-Nr.:		
Benennung:			Zeichnungs-Nr.		Alle Rechte vorbehalten
Nutzbare DGL RSTA 75/66 Modul (E130) mit Türblatt 42 und 64mm Band VX7729 und Bodeneinstand 40mm			z.B. 52mm bei Türschließer TS93		
Bemerkungen:			Ersatz für:		

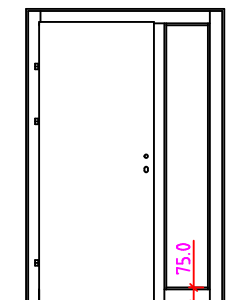

RST 1S-R Anschlag links

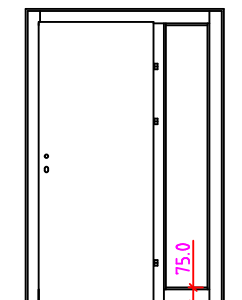

RST 1S-R Anschlag rechts

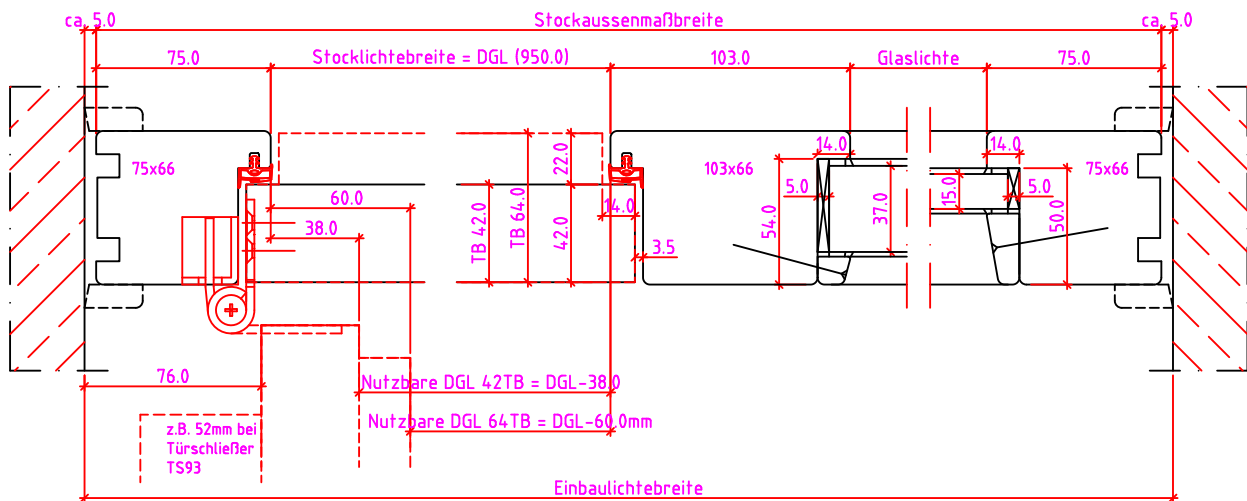
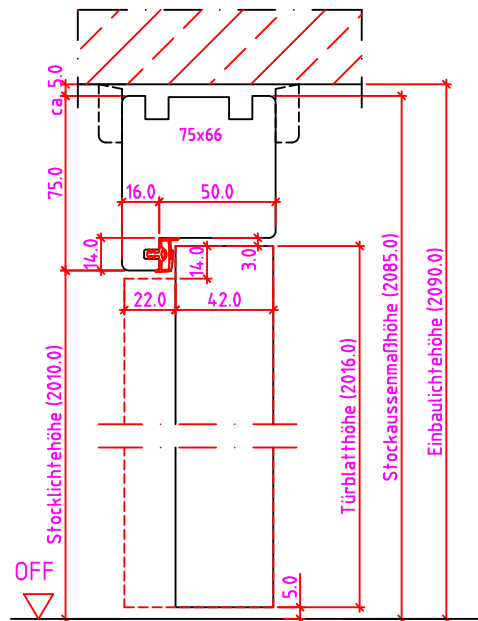

Maßangaben in mm

	Datum	Name	Objekt:	Maßstab:	 <p>Jeld-Wen Türen GmbH A-4582 Spital am Pyhrn</p>
Gez.:	10.12.14	agro	Kunde/Lieferant:		
Gepr.:	.	.	AB-Nr.:		
Benennung:	Nutzbare DGL RSTA 75/66 Modul (E130) mit Türblatt 42 und 64mm Band VX7729			Zeichnungs-Nr. 00693080 / A	
Bemerkungen:				Ersatz für:	Alle Rechte vorbehalten

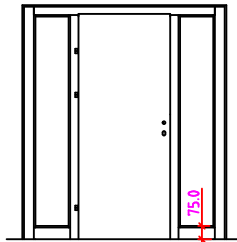

RST 2S Anschlag links

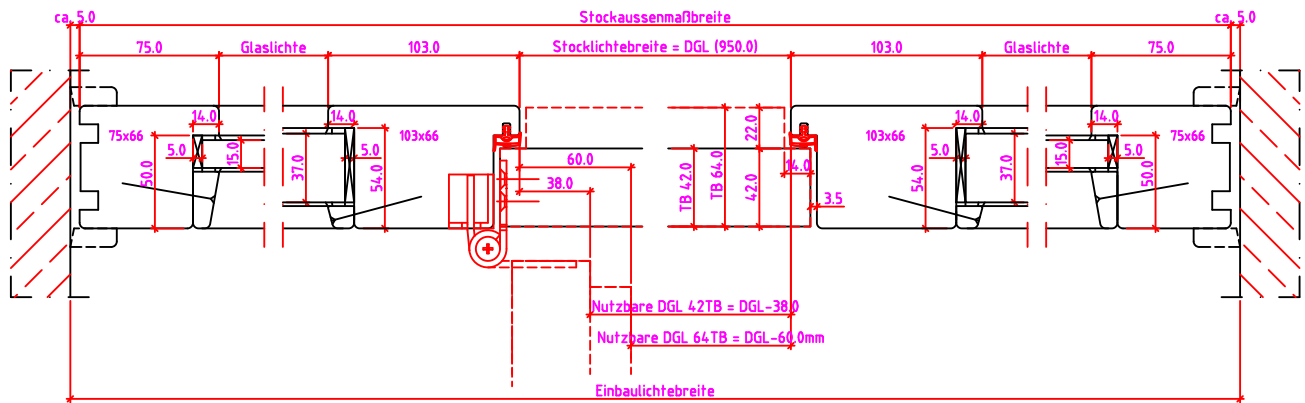
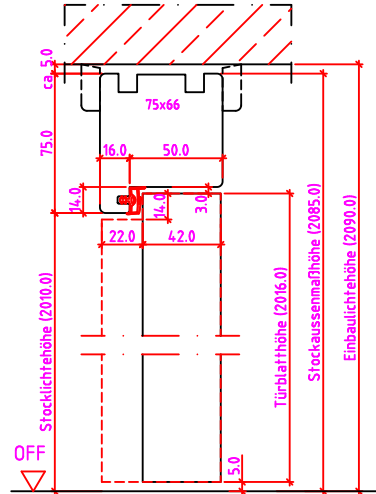

Maßangaben in mm

	Datum	Name	Objekt:	Maßstab:	 <p>Jeld-Wen Türen GmbH A-4582 Spital am Pyhrn</p>
Gez.:	10.12.14	agro	Kunde/Lieferant:		
Gepr.:	.	.	AB-Nr.:		
Benennung:	Nutzbare DGL RSTA 75/66 Modul (E130) mit Türblatt 42 und 64mm Band VX7729			Zeichnungs-Nr. 00693080 / A	
Bemerkungen:				Ersatz für:	Alle Rechte vorbehalten

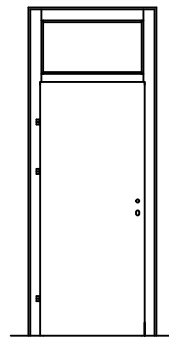

RST-K Anschlag links

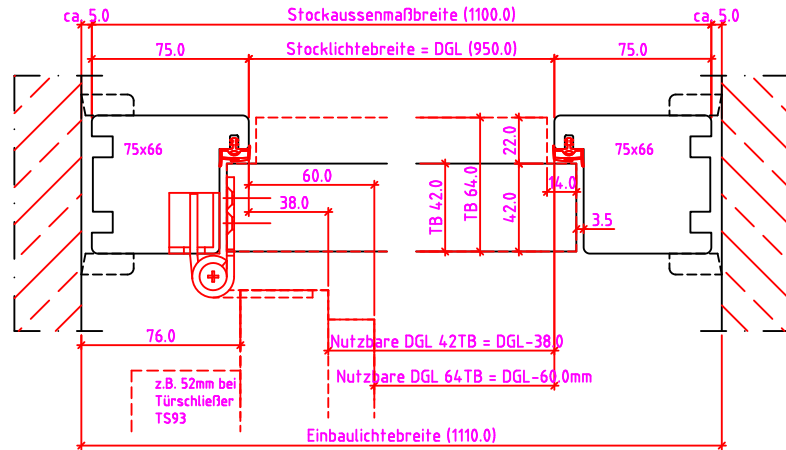
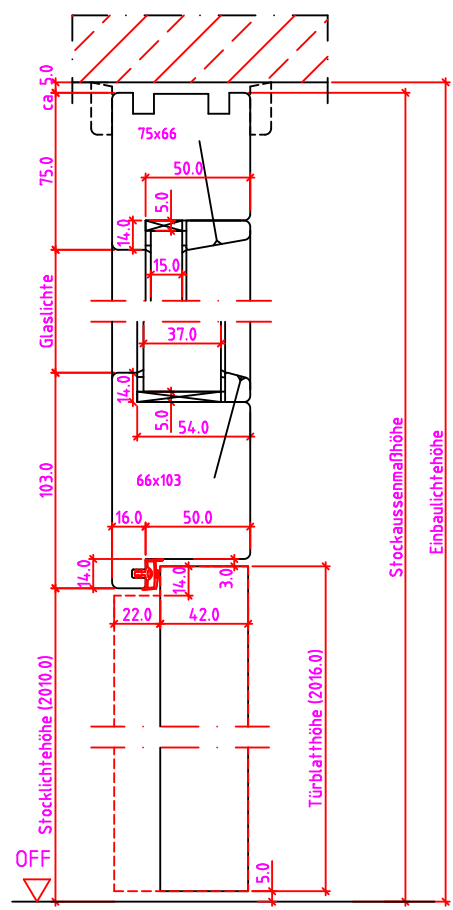
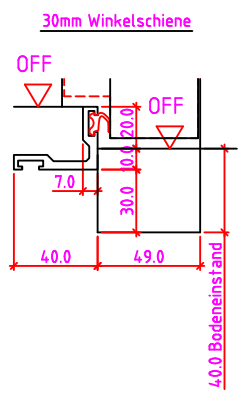
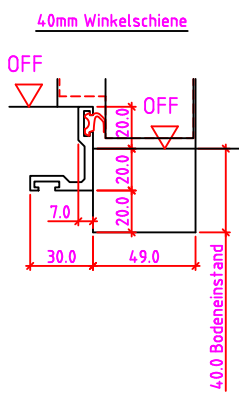

Maßangaben in mm

	Datum	Name	Objekt:	Maßstab:
Gez.:	10.12.14	agro	Kunde/Lieferant:	
Gepr.:	..		AB-Nr.:	
Benennung:	Nutzbare DGL RSTA 75/66 Modul (E130) mit Türblatt 42 und 64mm Band VX7729 und Bodeneinstand 40mm			Zeichnungs-Nr. 00693080 / A
Bemerkungen:				Ersatz für:

DANA[®]
 Jeld-Wen Türen GmbH
 A-4582 Spital am Pyhrn
 Alle Rechte vorbehalten

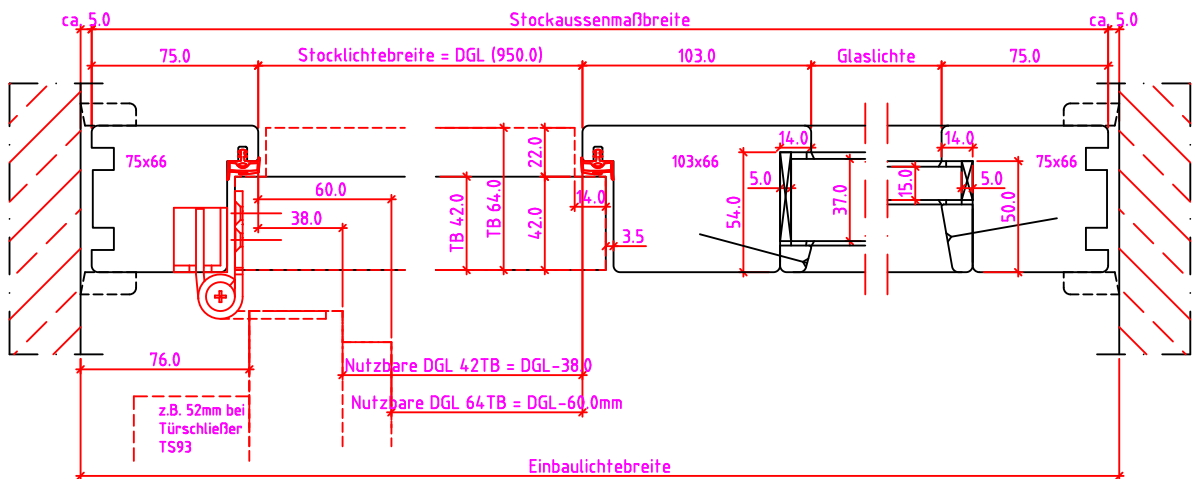
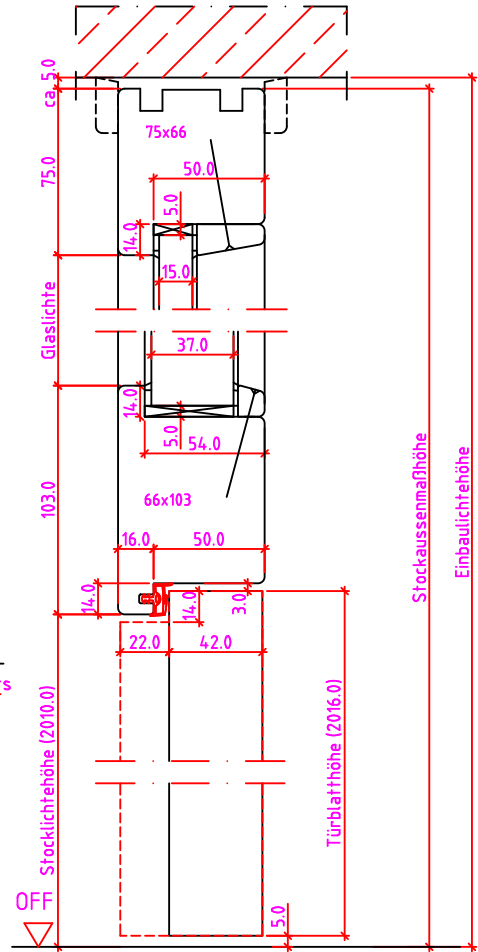

Maßangaben in mm

	Datum	Name	Objekt:	Maßstab:	 <p>Jeld-Wen Türen GmbH A-4582 Spital am Pyhrn</p>
Gez.:	10.12.14	agro	Kunde/Lieferant:		
Gepr.:	..		AB-Nr.:		
Benennung:	Nutzbare DGL RSTA 75/66 Modul (E130) mit Türblatt 42 und 64mm Band VX7729			Zeichnungs-Nr. 00693080 / A	
Bemerkungen:				Ersatz für:	Alle Rechte vorbehalten

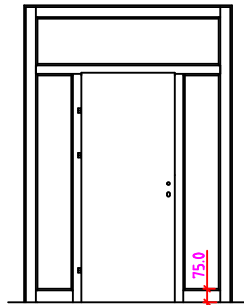

RST 2SK Anschlag links

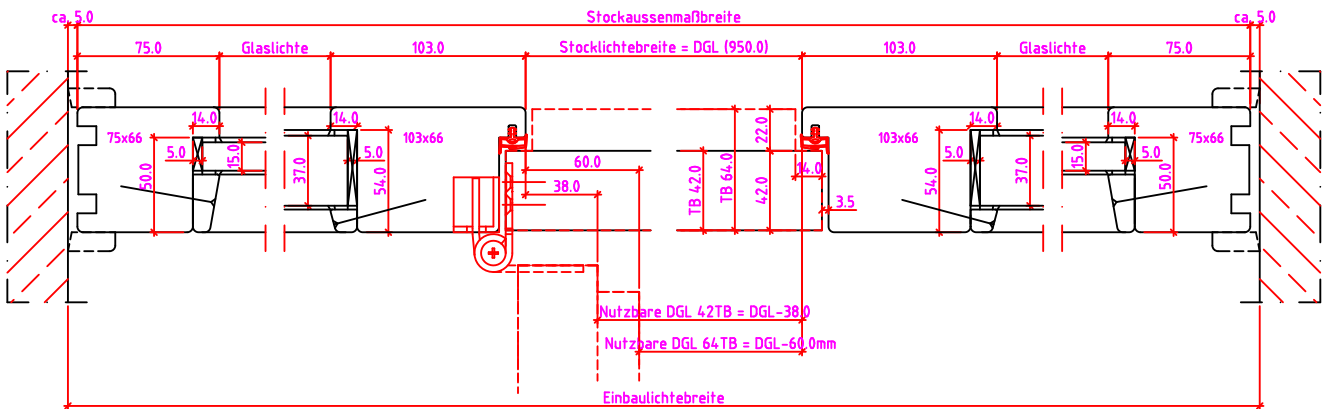
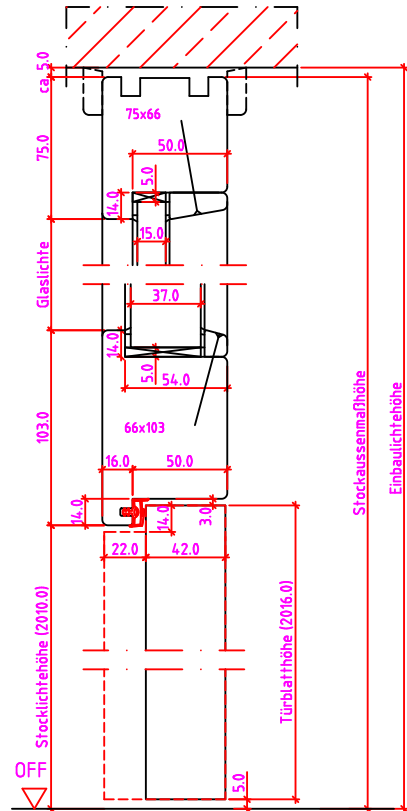

Maßangaben in mm

	Datum	Name	Objekt:	Maßstab:	 <p>Jeld-Wen Türen GmbH A-4582 Spital am Pyhrn</p>
Gez.:	10.12.14	agro	Kunde/Lieferant:		
Gepr.:	..		AB-Nr.:		
Benennung:	Nutzbare DGL RSTA 75/66 Modul (E130) mit Türblatt 42 und 64mm Band VX7729			Zeichnungs-Nr. 00693080 / A	
Bemerkungen:				Ersatz für:	Alle Rechte vorbehalten

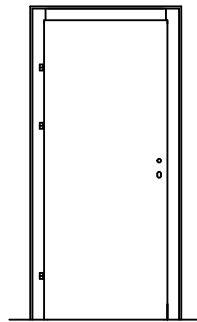

Anschlag links

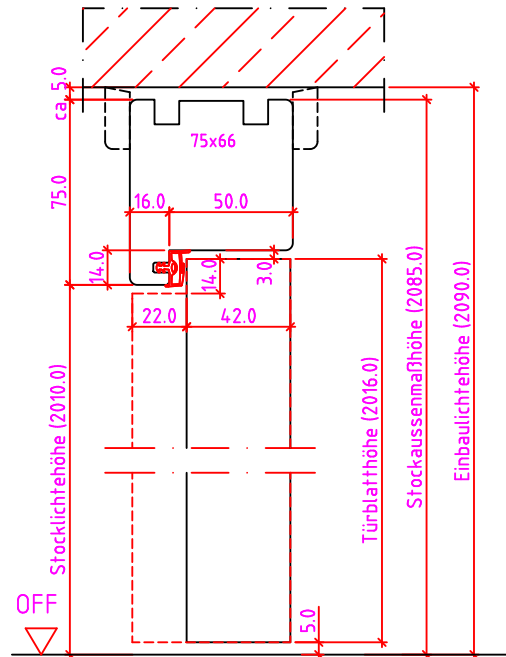

40mm Winkelschiene

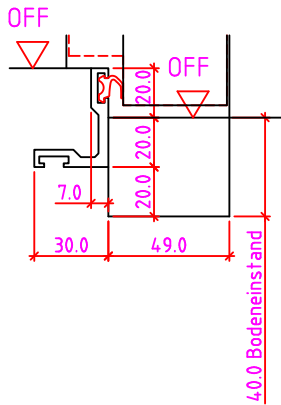

30mm Winkelschiene

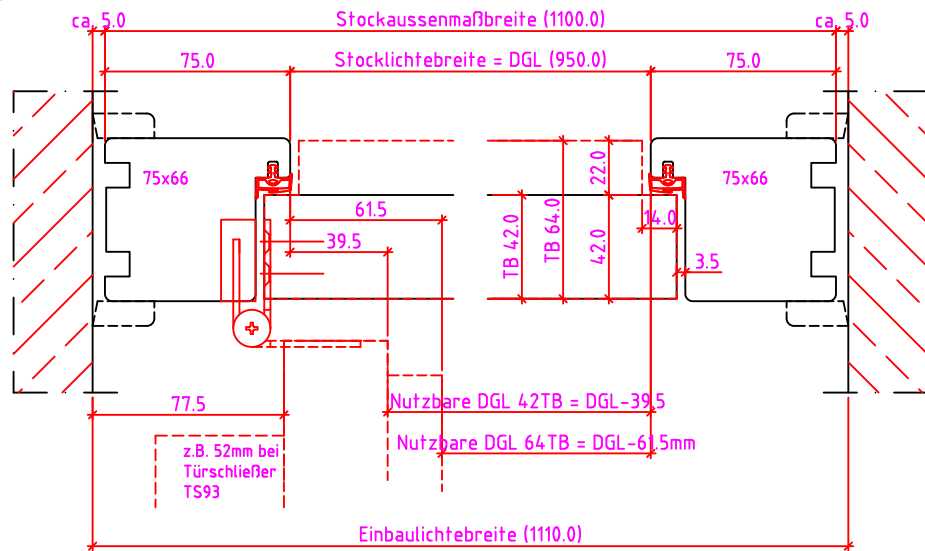
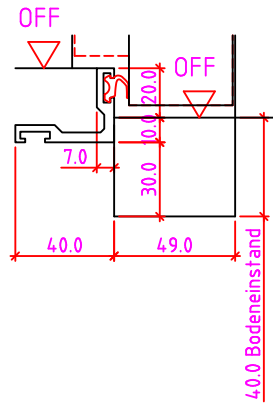

Maßangaben in mm

	Datum	Name	Objekt:	Maßstab:	 <p>Jeld-Wen Türen GmbH A-4582 Spital am Pyhrn</p>
Gez.:	10.12.14	agro	Kunde/Lieferant:		
Gepr.:	.	.	AB-Nr.:		
Benennung:	Nutzbare DGL RSTA 75/66 Modul mit Türblatt 42 und 64mm Band V7888 und Bodeneinstand 40mm			Zeichnungs-Nr. 00693080 / A	
Bemerkungen:				Ersatz für:	Alle Rechte vorbehalten

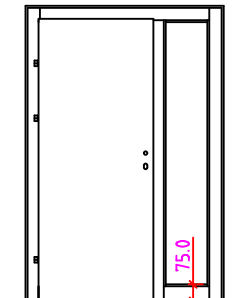

RST 1S-R Anschlag links

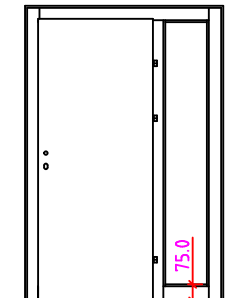

RST 1S-R Anschlag rechts

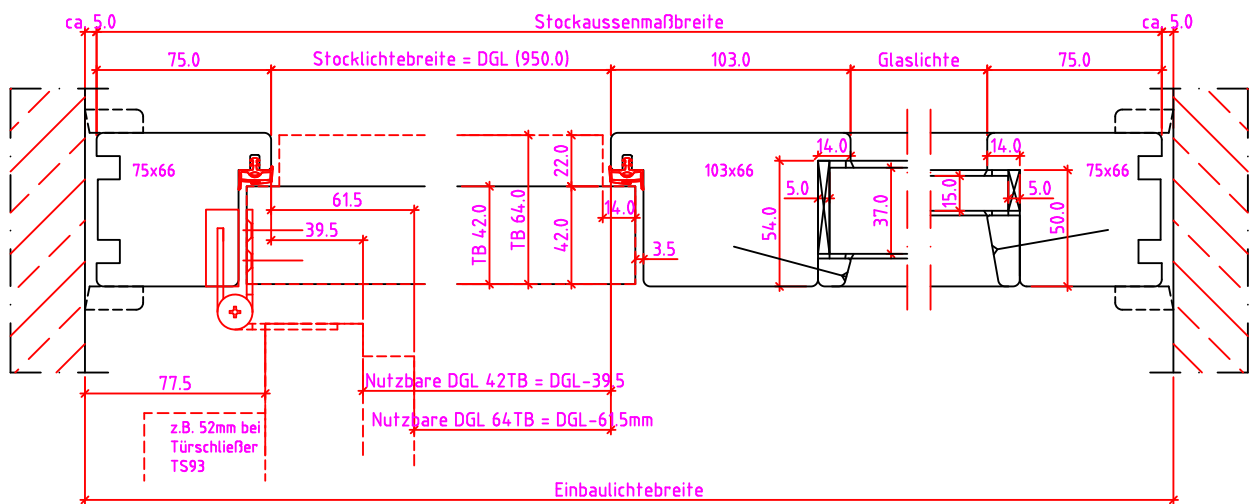
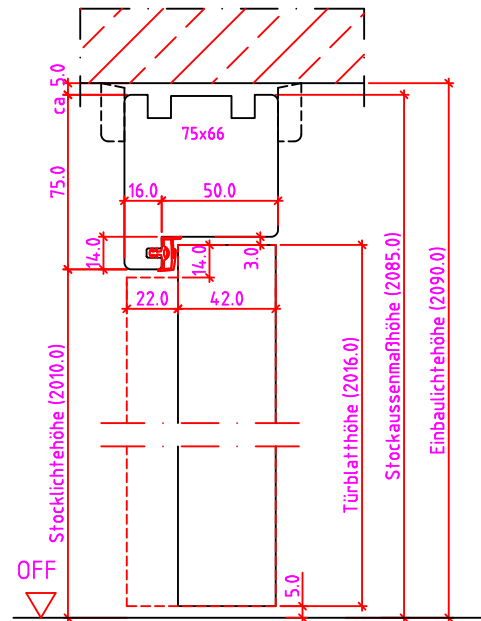

Maßangaben in mm

	Datum	Name	Objekt:	Maßstab:	 <p>Jeld-Wen Türen GmbH A-4582 Spital am Pyhrn</p>
Gez.:	10.12.14	agro	Kunde/Lieferant:		
Gepr.:			AB-Nr.:		
Benennung:	Nutzbare DGL RSTA 75/66 Modul mit Türblatt 42 und 64mm Band V7888			Zeichnungs-Nr. 00693080 / A	
Bemerkungen:				Ersatz für:	Alle Rechte vorbehalten

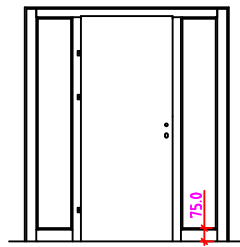

RST 2S Anschlag links

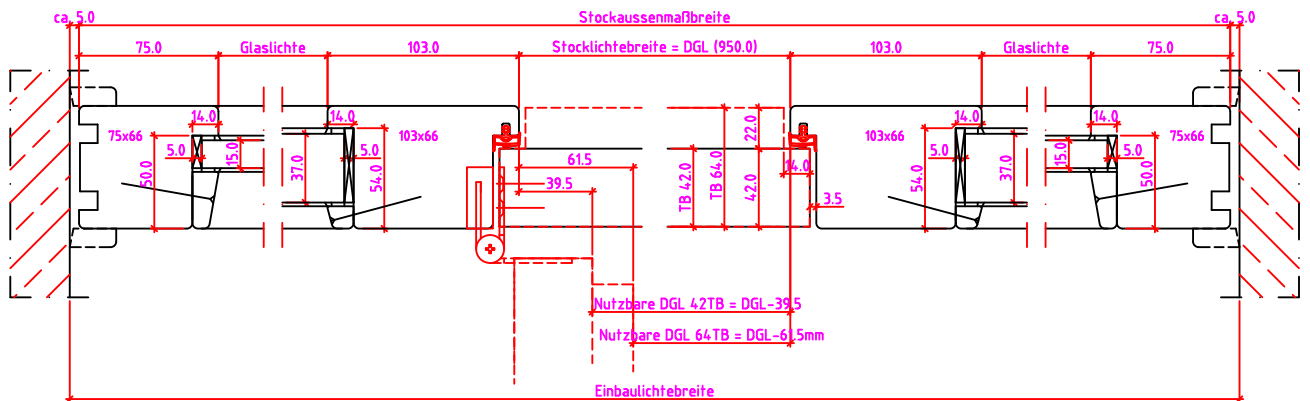
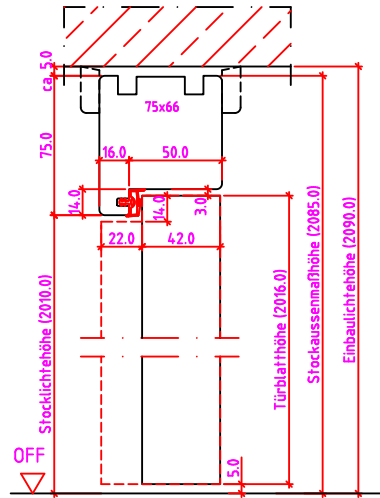

Maßangaben in mm

	Datum	Name	Objekt:	Maßstab:	 <p>Jeld-Wen Türen GmbH A-4582 Spital am Pyhrn</p>
Gez.:	10.12.14	agro	Kunde/Lieferant:		
Gepr.:	.	.	AB-Nr.:		
Benennung:	Nutzbare DGL RSTA 75/66 Modul mit Türblatt 42 und 64mm Band V7888			Zeichnungs-Nr. 00693080 / A	
Bemerkungen:				Ersatz für:	Alle Rechte vorbehalten

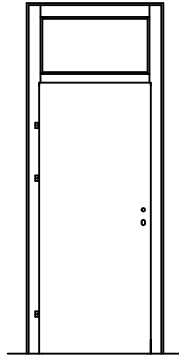

RST-K Anschlag links

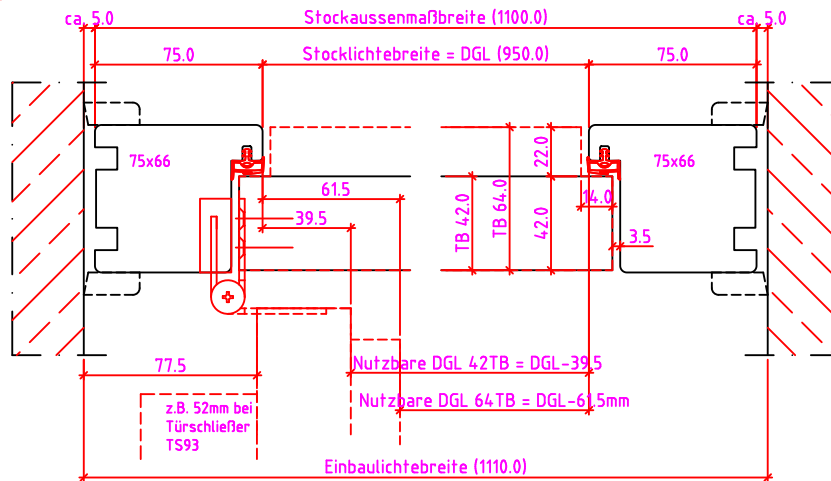
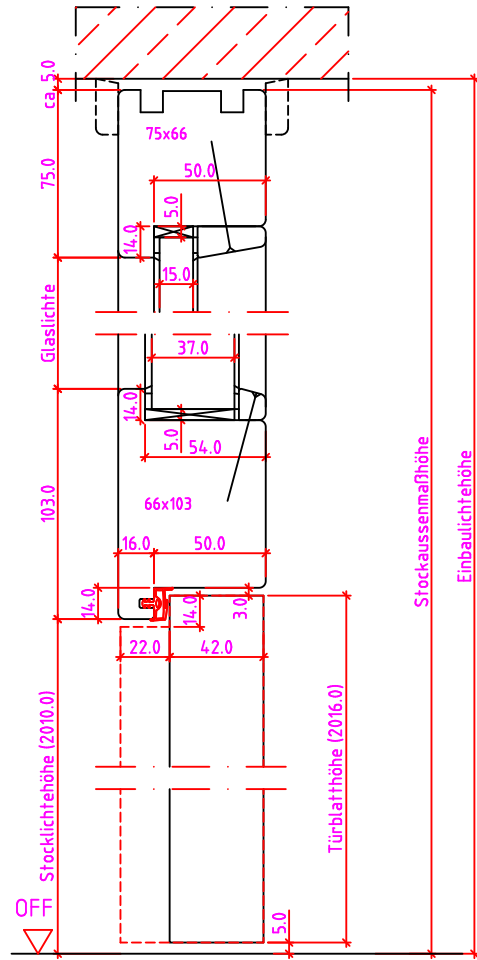
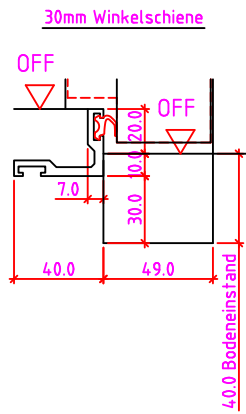
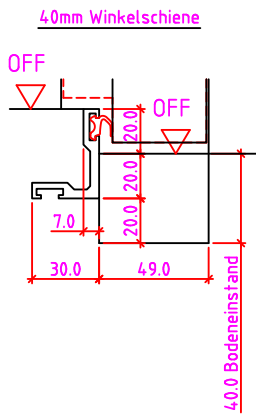

Maßangaben in mm

	Datum	Name	Objekt:	Maßstab:	 <p>Jeld-Wen Türen GmbH A-4582 Spital am Pyhrn</p>
Gez.:	10.12.14	agro	Kunde/Lieferant:		
Gepr.:			AB-Nr.:		
Benennung:	Nutzbare DGL RSTA 75/66 Modul mit Türblatt 42 und 64mm Band V7888 und Bodeneinstand 40mm			Zeichnungs-Nr. 00693080 / A	<p>Alle Rechte vorbehalten</p>
Bemerkungen:				Ersatz für:	

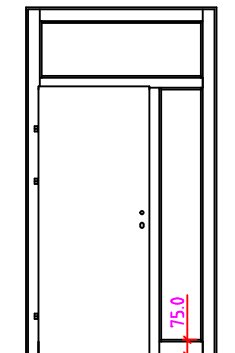

RST 1SK-R Anschlag links

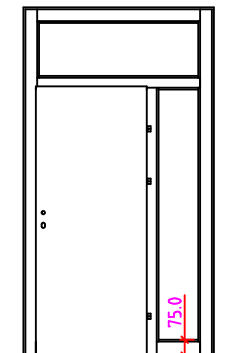

RST 1SK-R Anschlag rechts

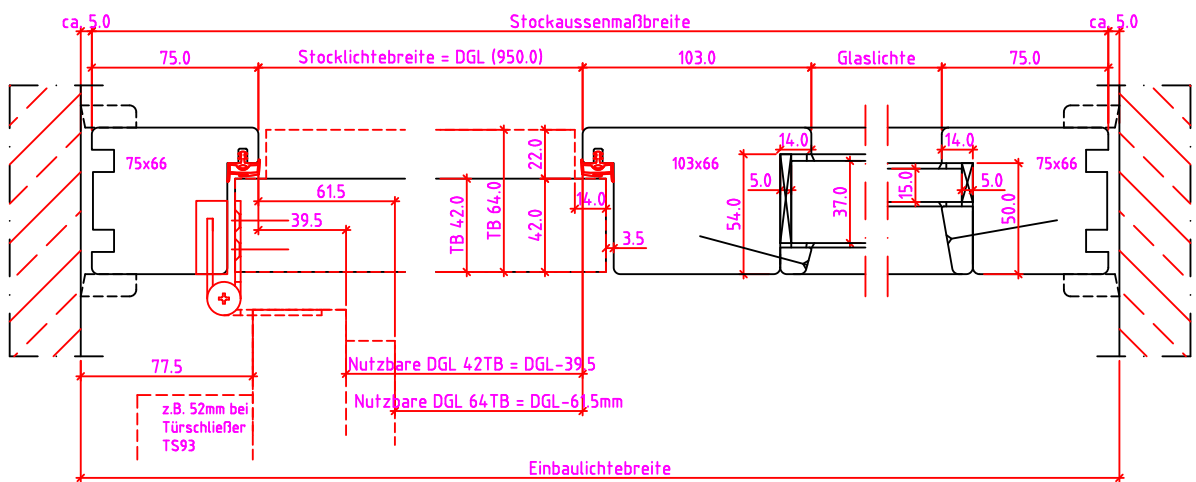
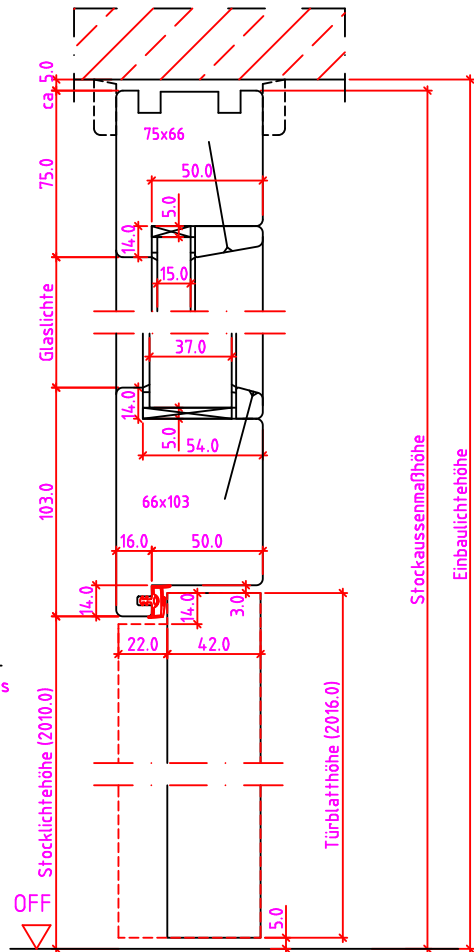

Maßangaben in mm

	Datum	Name	Objekt:	Maßstab:	 <p>Jeld-Wen Türen GmbH A-4582 Spital am Pyhrn</p>
Gez.:	10.12.14	agro	Kunde/Lieferant:		
Gepr.:			AB-Nr.:		
Benennung:	Nutzbare DGL RSTA 75/66 Modul mit Türblatt 42 und 64mm Band V7888			Zeichnungs-Nr. 00693080 / A	
Bemerkungen:				Ersatz für:	Alle Rechte vorbehalten

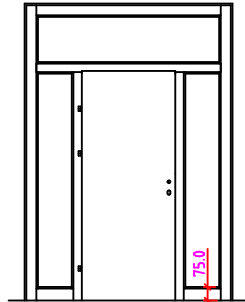

RST 2SK Anschlag links

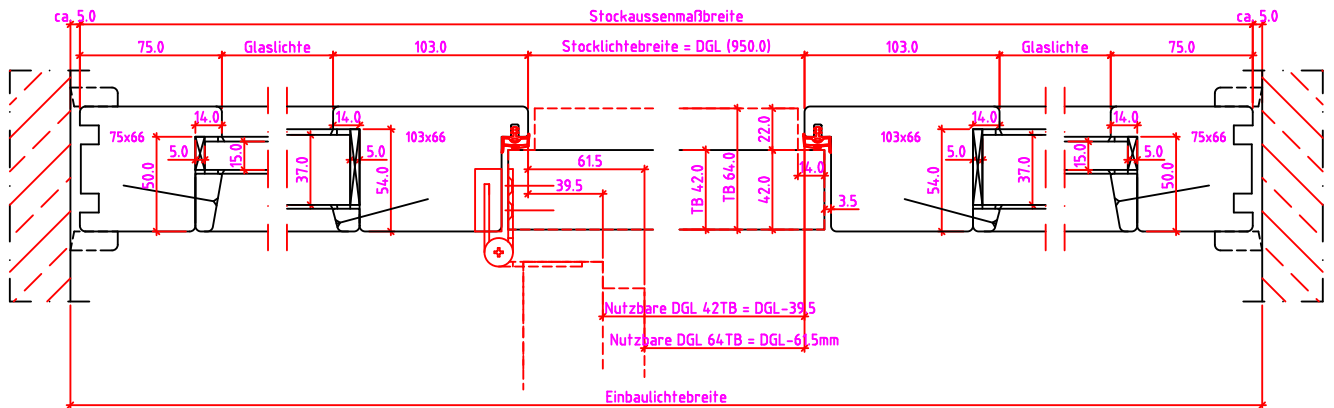
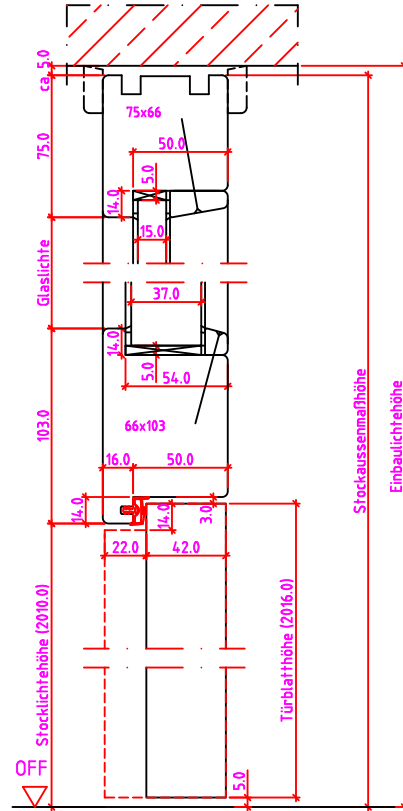

Maßangaben in mm

	Datum	Name	Objekt:	Maßstab:	 <p>Jeld-Wen Türen GmbH A-4582 Spital am Pyhrn</p>
Gez.:	10.12.14	agro	Kunde/Lieferant:		
Gepr.:	.	.	AB-Nr.:		
Benennung:			Zeichnungs-Nr.		
RSTA 75/66 Modul mit Türblatt 42 und 64mm Band V7888			00693080 / A		
Bemerkungen:			Ersatz für:		Alle Rechte vorbehalten

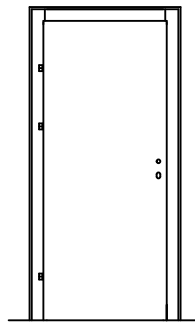

Anschlag links

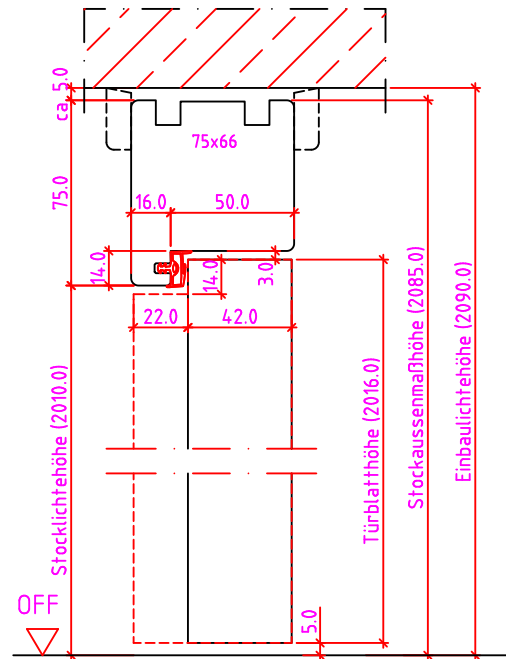

40mm Winkelschiene

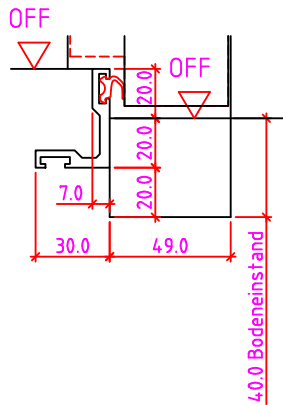

30mm Winkelschiene

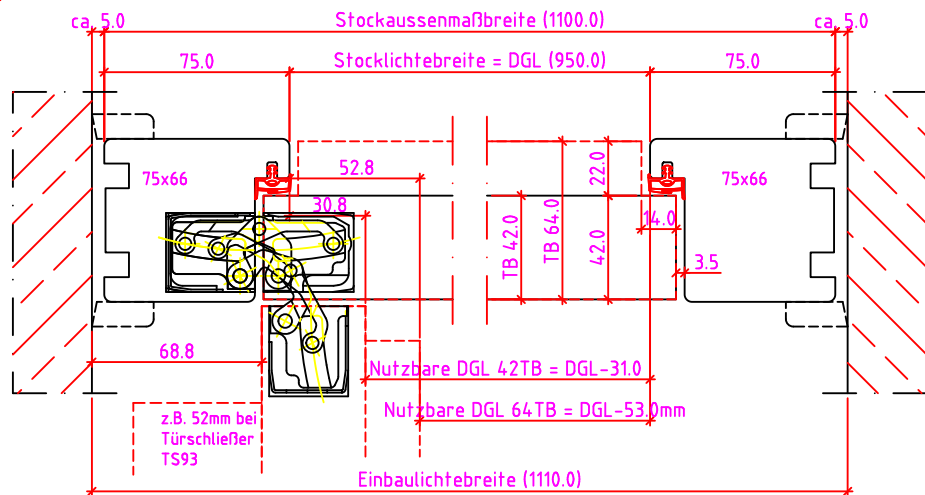
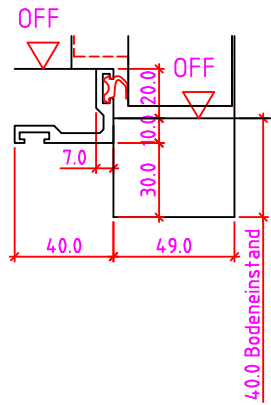

Maßangaben in mm

	Datum	Name	Objekt:	Maßstab:	 <p>Jeld-Wen Türen GmbH A-4582 Spital am Pyhrn</p>
Gez.:	10.12.14	agro	Kunde/Lieferant:		
Gepr.:	.	.	AB-Nr.:		
Benennung:	Nutzbare DGL RSTA 75/66 Modul (E130) mit Türblatt 42 und 64mm mit TE540 und Bodeneinstand 40mm			Zeichnungs-Nr. 00693080 / A	
Bemerkungen:				Ersatz für:	Alle Rechte vorbehalten

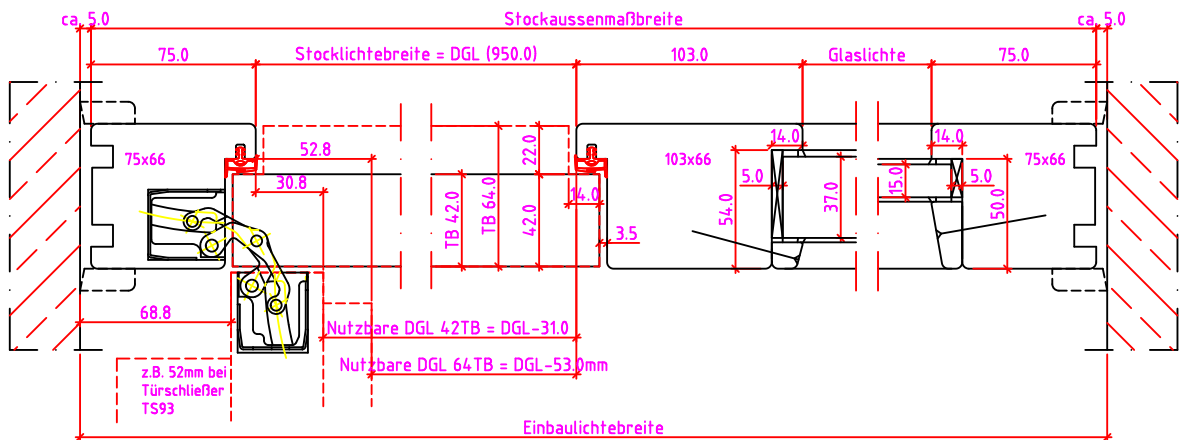
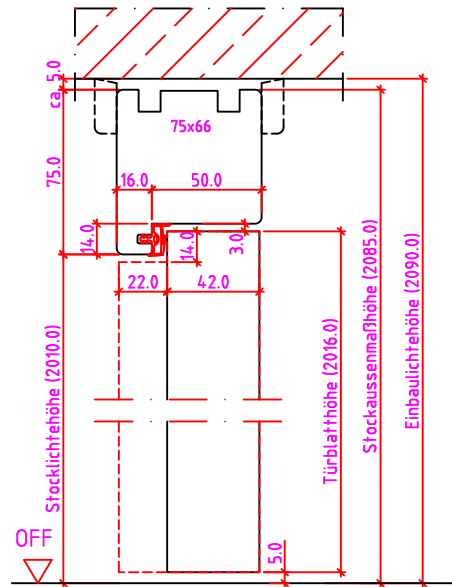
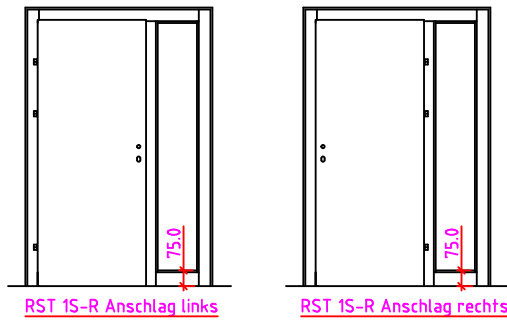

Maßangaben in mm

	Datum	Name	Objekt:	Maßstab:	 <p>Jeld-Wen Türen GmbH A-4582 Spital am Pyhrn</p>
Gez.:	10.12.14	agro	Kunde/Lieferant:		
Gepr.:	.	.	AB-Nr.:		
Benennung:	Nutzbare DGL RSTA 75/66 Modul (E130) mit Türblatt 42 und 64mm und TE540 Band			Zeichnungs-Nr. 00693080 / A	
Bemerkungen:				Ersatz für:	Alle Rechte vorbehalten

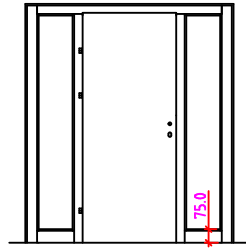

RST 2S Anschlag links

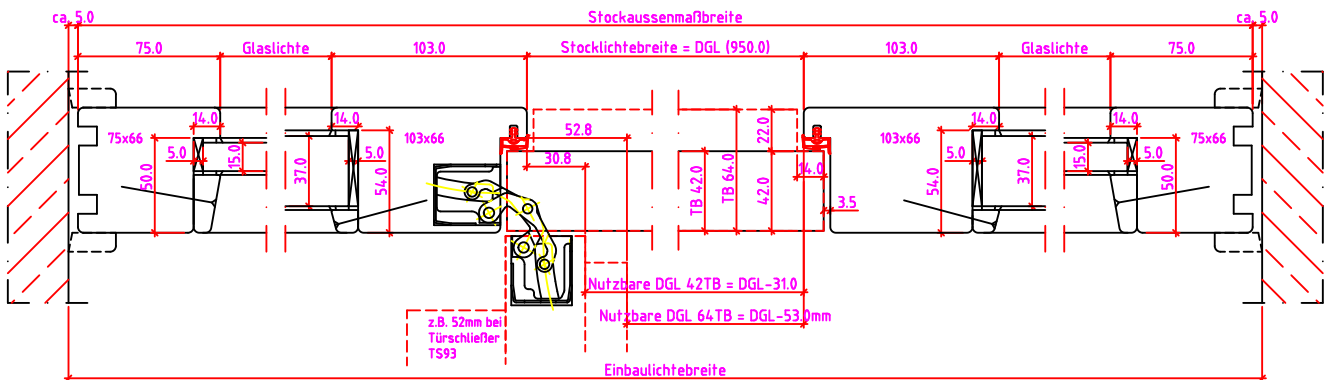
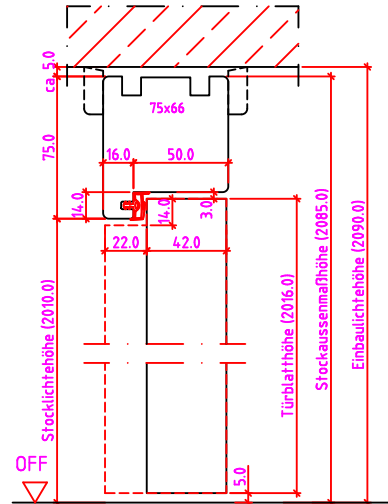

Maßangaben in mm

	Datum	Name	Objekt:	Maßstab:	 <p>Jeld-Wen Türen GmbH A-4582 Spital am Pyhrn</p>
Gez.:	10.12.14	agro	Kunde/Lieferant:		
Gepr.:			AB-Nr.:		
Benennung:	Nutzbare DGL RSTA 75/66 Modul (E130) mit Türblatt 42 und 64mm und TE540 Band			Zeichnungs-Nr. 00693080 / A	
Bemerkungen:				Ersatz für:	Alle Rechte vorbehalten

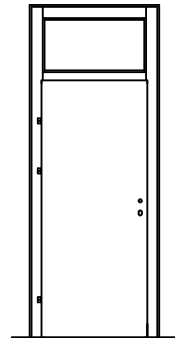

RST-K Anschlag links

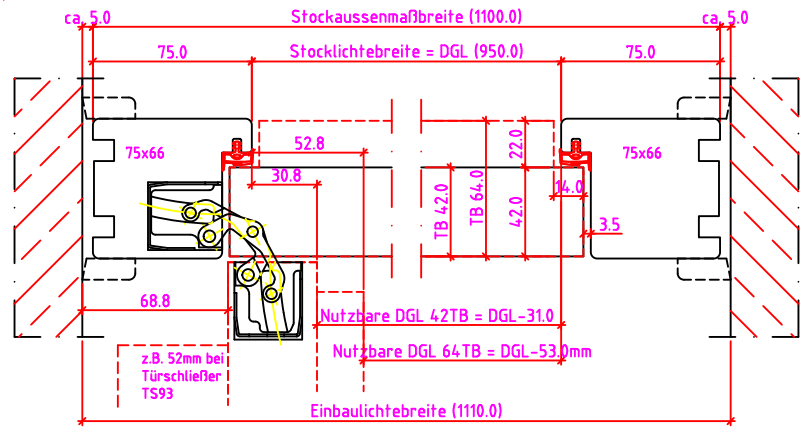
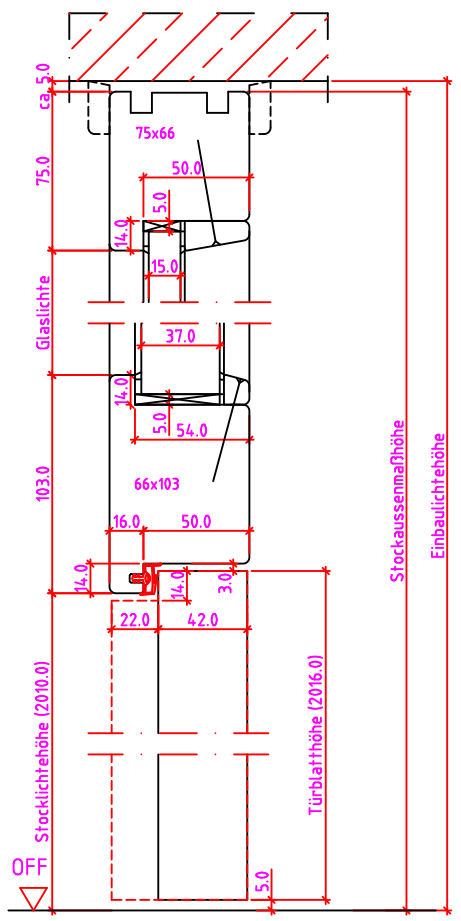
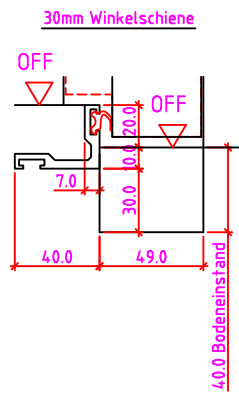
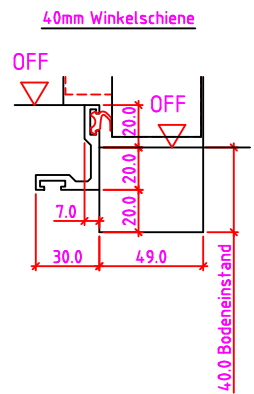

Maßangaben in mm

	Datum	Name	Objekt:	Maßstab:
Gez.:	10.12.14	agro	Kunde/Lieferant:	
Gepr.:			AB-Nr.:	
Benennung:	Nutzbare DGL RSTA 75/66 Modul (E130) mit Türblatt 42 und 64mm und TE540 Band			Zeichnungs-Nr. 00693080 / A
Bemerkungen:				Ersatz für:

DANA®
 Jeld-Wen Türen GmbH
 A-4582 Spital am Pyhrn
 Alle Rechte vorbehalten

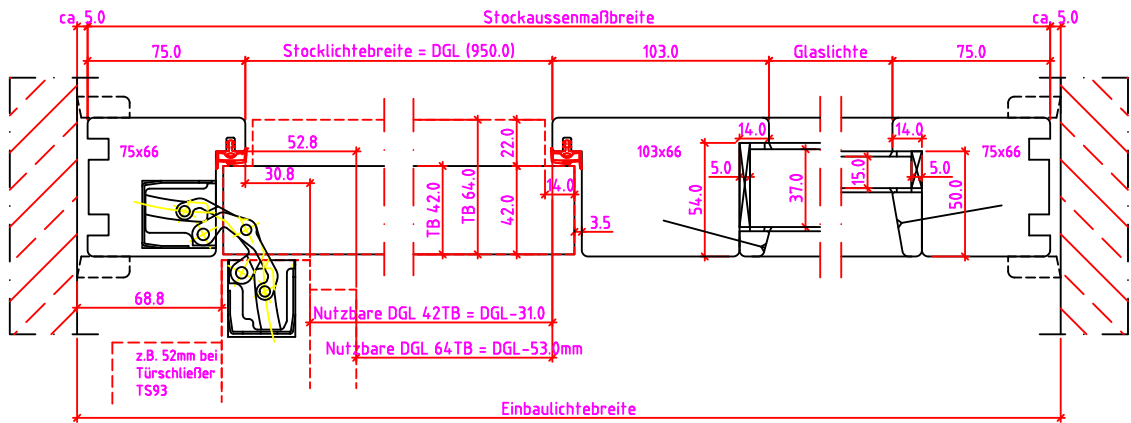
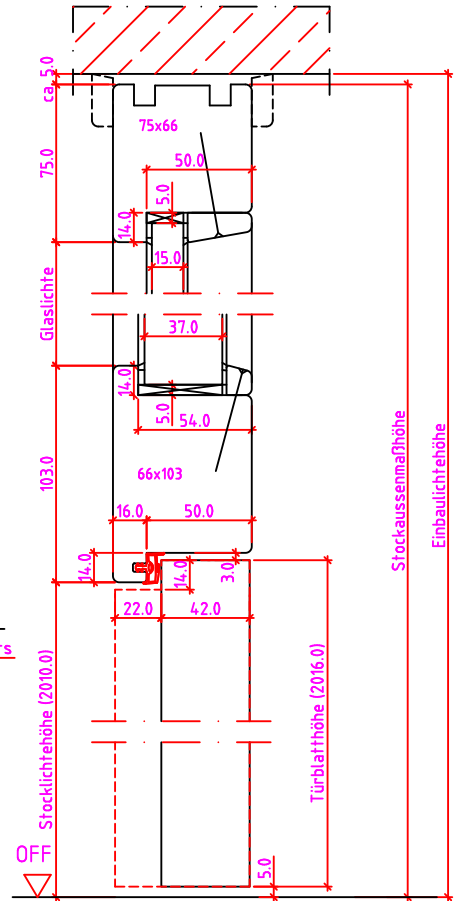

Maßangaben in mm

	Datum	Name	Objekt:	Maßstab:	 <p>Jeld-Wen Türen GmbH A-4582 Spital am Pyhrn</p>
Gez.:	10.12.14	agro	Kunde/Lieferant:		
Gepr.:			AB-Nr.:		
Benennung:	Nutzbare DGL RSTA 75/66 Modul (E130) mit Türblatt 42 und 64mm und TE540 Band			Zeichnungs-Nr. 00693080 / A	
Bemerkungen:				Ersatz für:	Alle Rechte vorbehalten

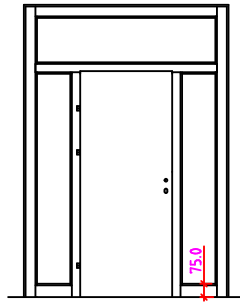

RST 2SK Anschlag links

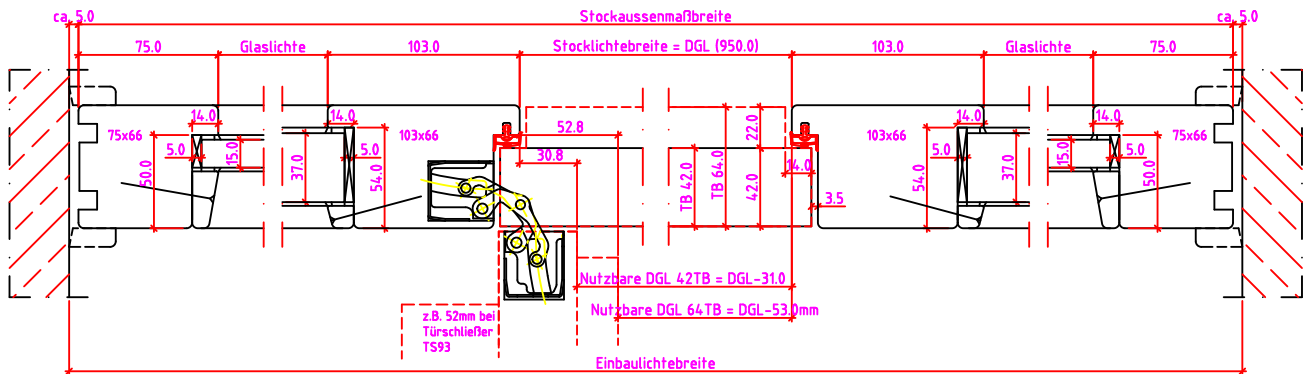
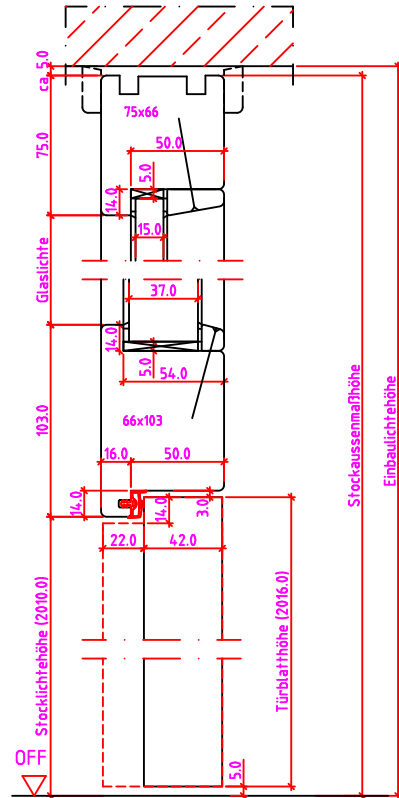

Maßangaben in mm

	Datum	Name	Objekt:	Maßstab:	 <p>Jeld-Wen Türen GmbH A-4582 Spital am Pyhrn</p>
Gez.:	10.12.14	agro	Kunde/Lieferant:		
Gepr.:	.	.	AB-Nr.:		
Benennung:	Nutzbare DGL RSTA 75/66 Modul (E130) mit Türblatt 42 und 64mm und TE540 Band			Zeichnungs-Nr.	00693080 / A
Bemerkungen:				Ersatz für:	Alle Rechte vorbehalten

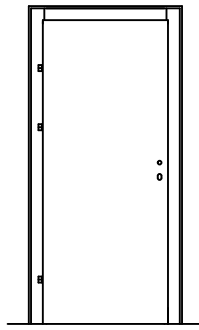

Anschlag links

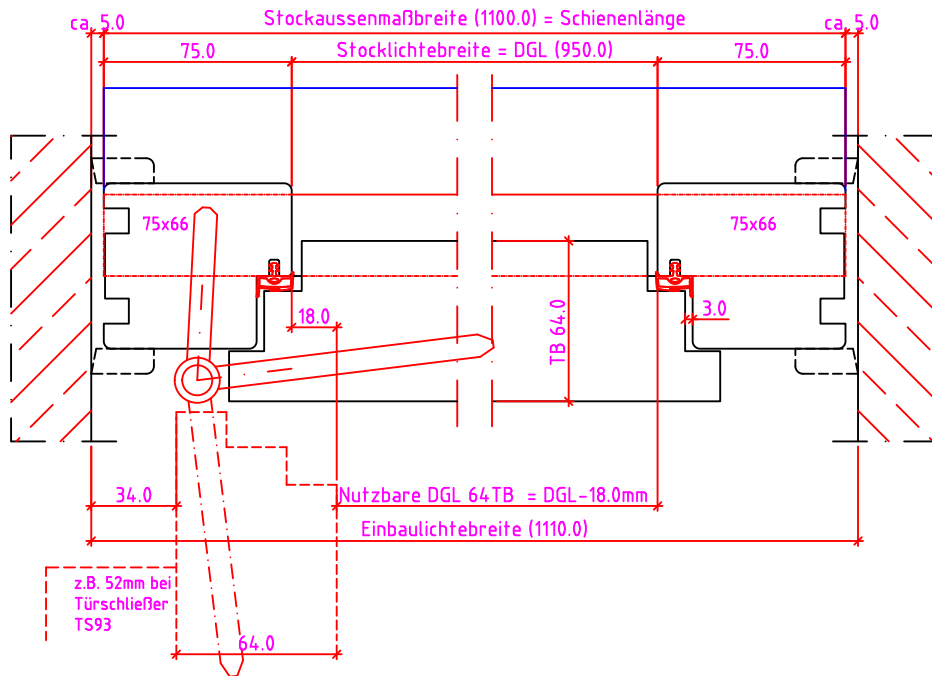
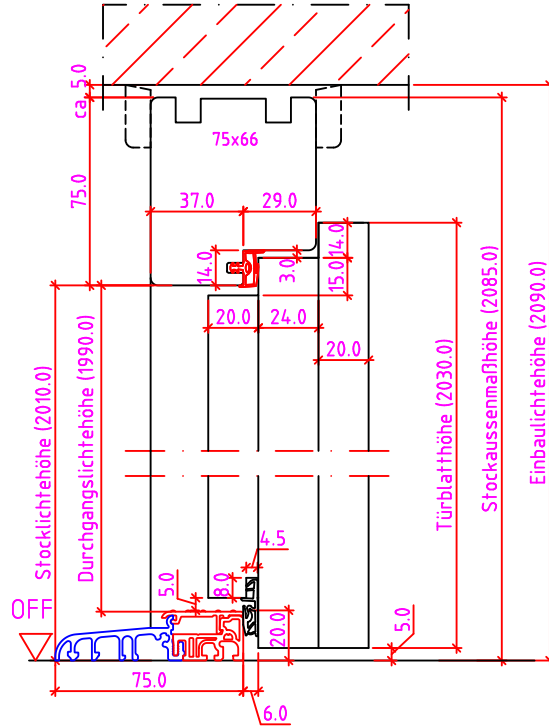

Maßangaben in mm

	Datum	Name	Objekt:	Maßstab:	 <p>Jeld-Wen Türen GmbH A-4582 Spital am Pyhrn</p>
Gez.:	20-10-2016	gsu	Kunde/Lieferant:	<p>00787714 / C</p>	
Gepr.:	06.07.17	gsu	AB-Nr.:		
Benennung:			Zeichnungs-Nr.		Alle Rechte vorbehalten
<p>Nutzbare DGL RSTA 75/66 gefälzt (EI30) 64mm Eiffel Bodenschiene</p>			<p>Ersatz für:</p>		
Bemerkungen:					

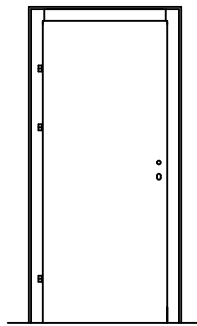

Anschlag links

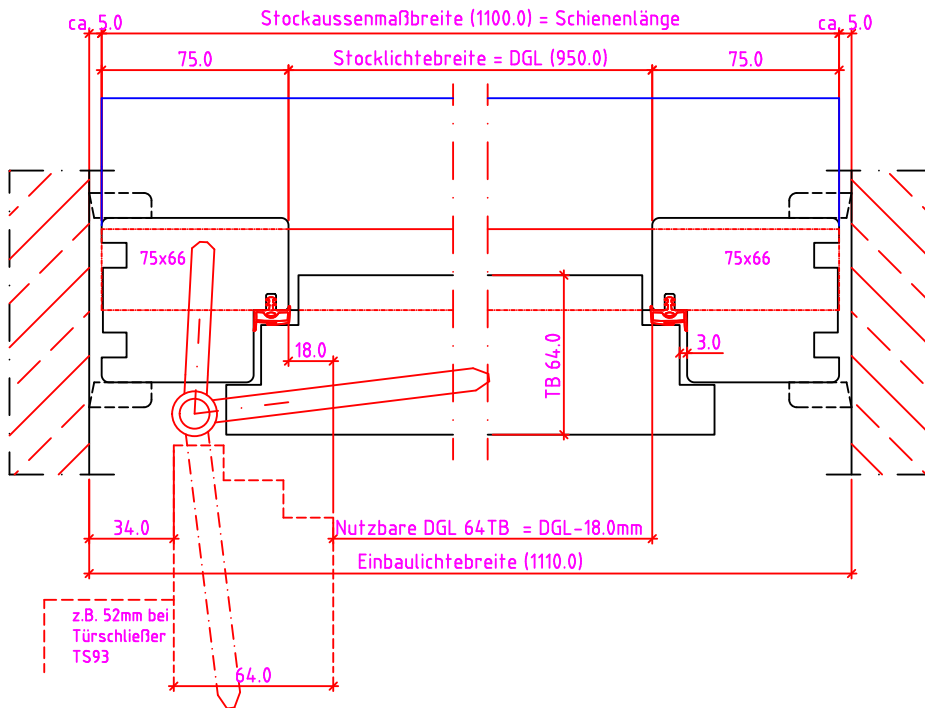
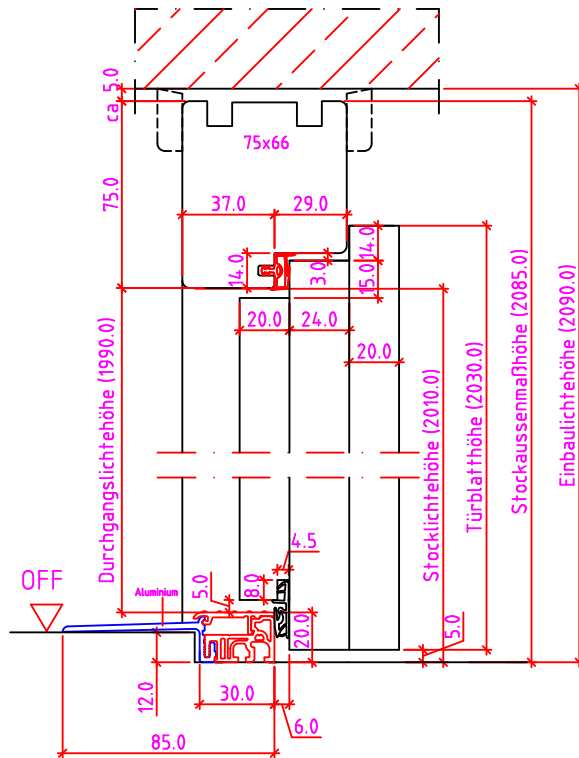

Maßangaben in mm

	Datum	Name	Objekt:	Maßstab:	 <p>Jeld-Wen Türen GmbH A-4582 Spital am Pyhrn</p>
Gez.:	20-10-2016	gsu	Kunde/Lieferant:	00787714 / C	
Gepr.:	06.07.17	gsu	AB-Nr.:		
Benennung:			Zeichnungs-Nr.		Alle Rechte vorbehalten
Nutzbare DGL RSTA 75/66 gefälzt (EI30) 64mm Eiffel Bodenschiene			00787714 / C		
Bemerkungen:			Ersatz für:		

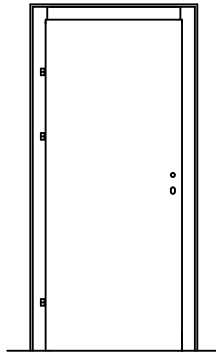

Anschlag links

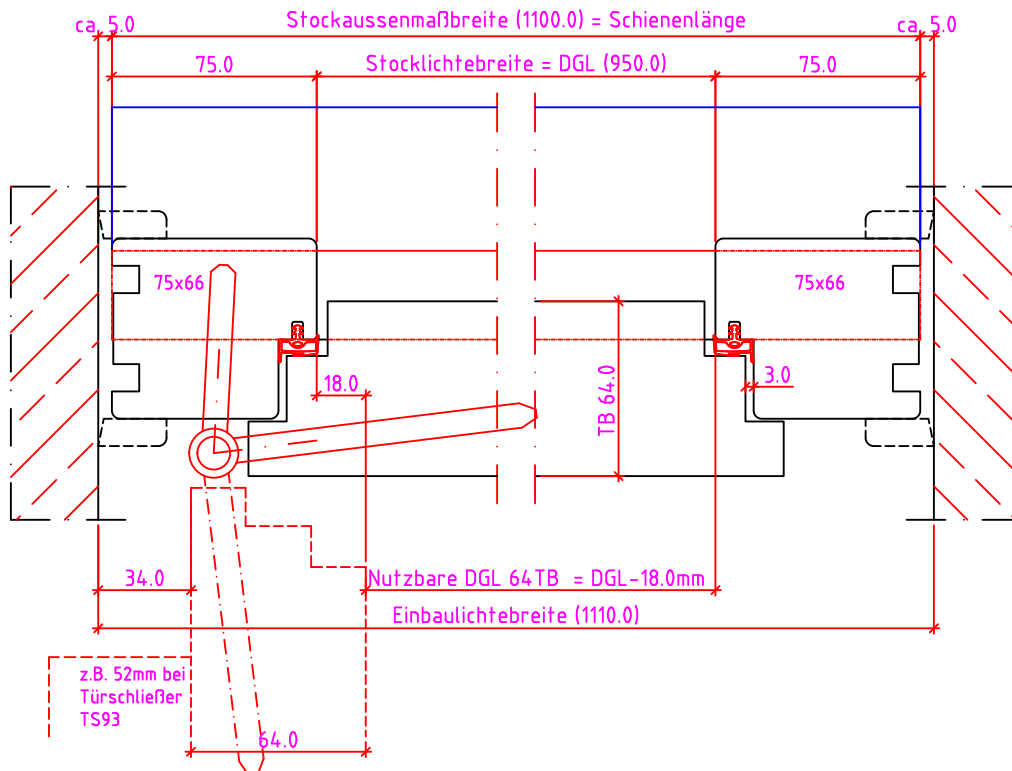
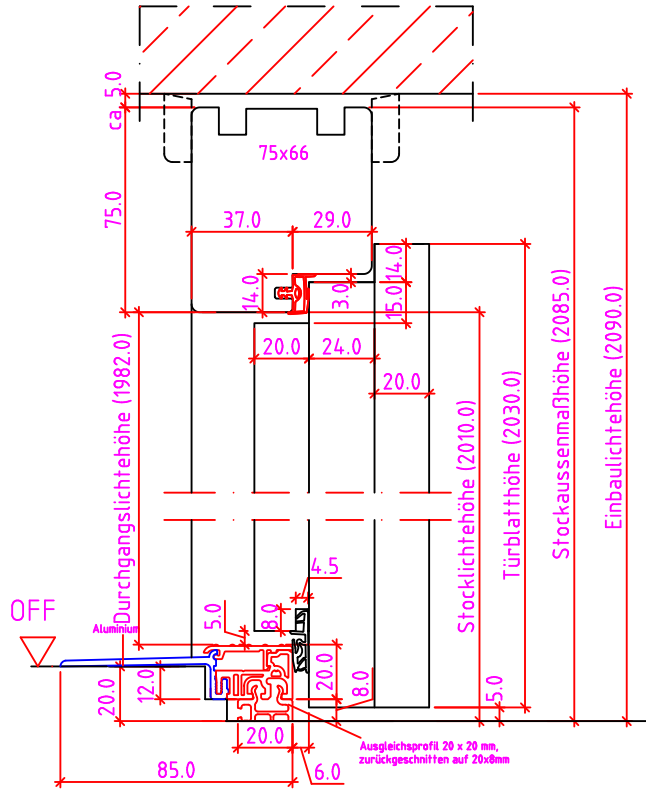

Maßangaben in mm

	Datum	Name	Objekt:	Maßstab:	 <p>Jeld-Wen Türen GmbH A-4582 Spital am Pyhrn</p>
Gez.:	20-10-2016	gsu	Kunde/Lieferant:		
Gepr.:	06.07.17	gsu	AB-Nr.:		
Benennung:	Nutzbare DGL RSTA 75/66 gefälzt (EI30) 64mm Eiffel Bodenschiene			Zeichnungs-Nr.	00787714 / C
Bemerkungen:				Ersatz für:	Alle Rechte vorbehalten

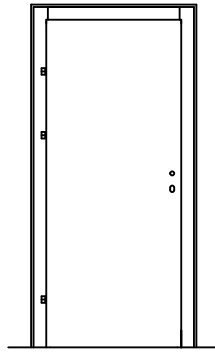

Anschlag links

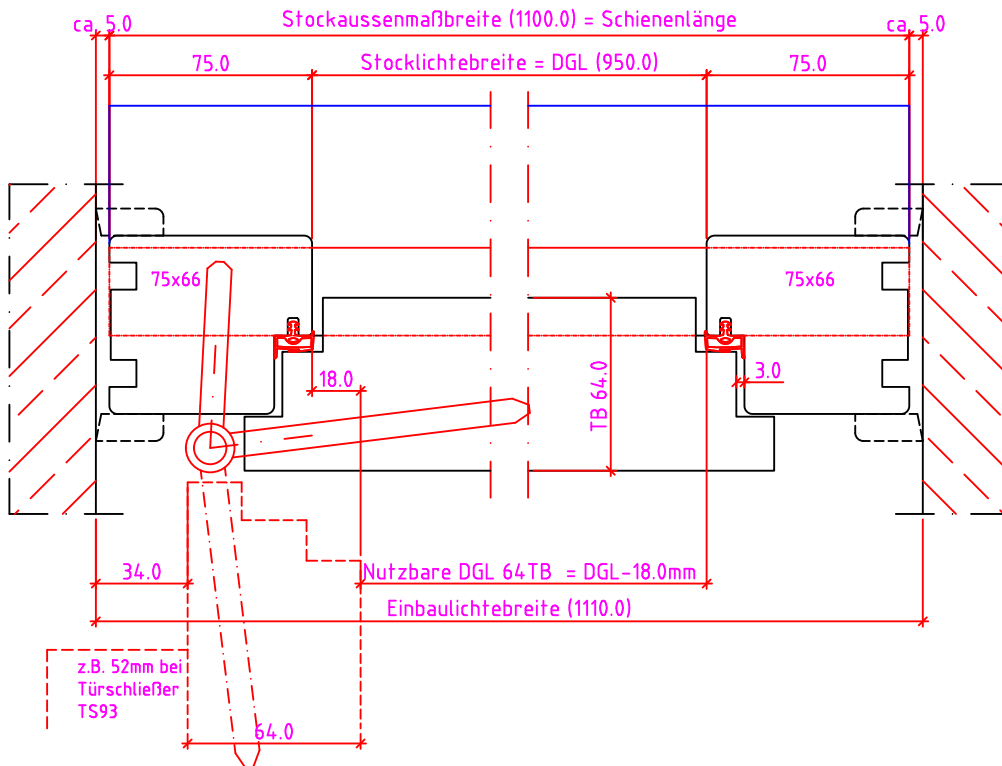
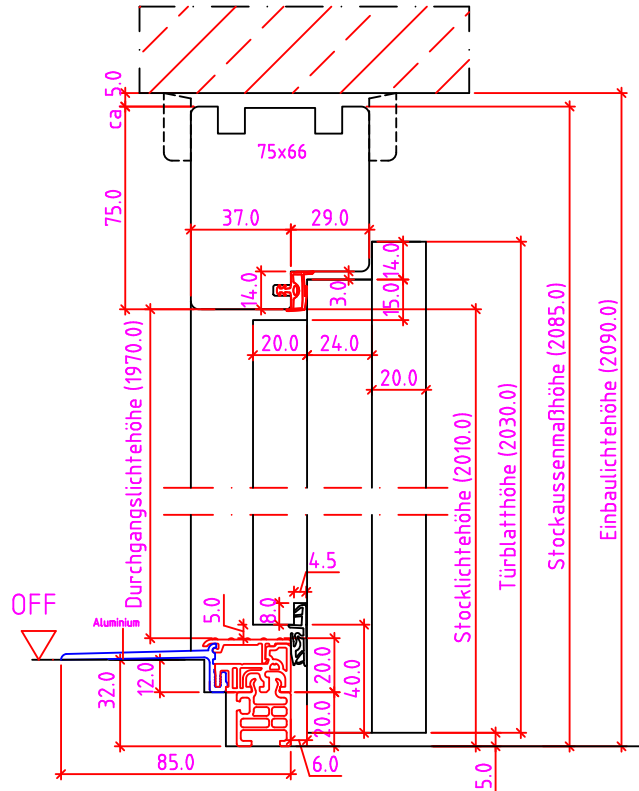

Maßangaben in mm

	Datum	Name	Objekt:	Maßstab:	 <p>Jeld-Wen Türen GmbH A-4582 Spital am Pyhrn</p>
Gez.:	20-10-2016	gsu	Kunde/Lieferant:		
Gepr.:	06.07.17	gsu	AB-Nr.:		
Benennung:	Nutzbare DGL RSTA 75/66 gefälzt (EI30) 64mm Eiffel Bodenschiene			Zeichnungs-Nr.	00787714 / C
Bemerkungen:				Ersatz für:	Alle Rechte vorbehalten

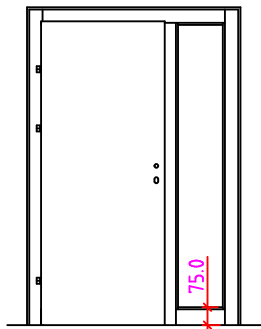

RST 1S-R Anschlag links

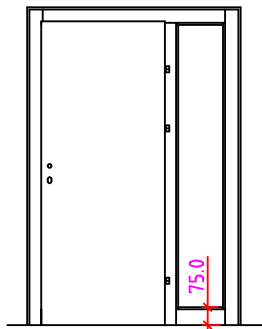

RST 1S-R Anschlag rechts

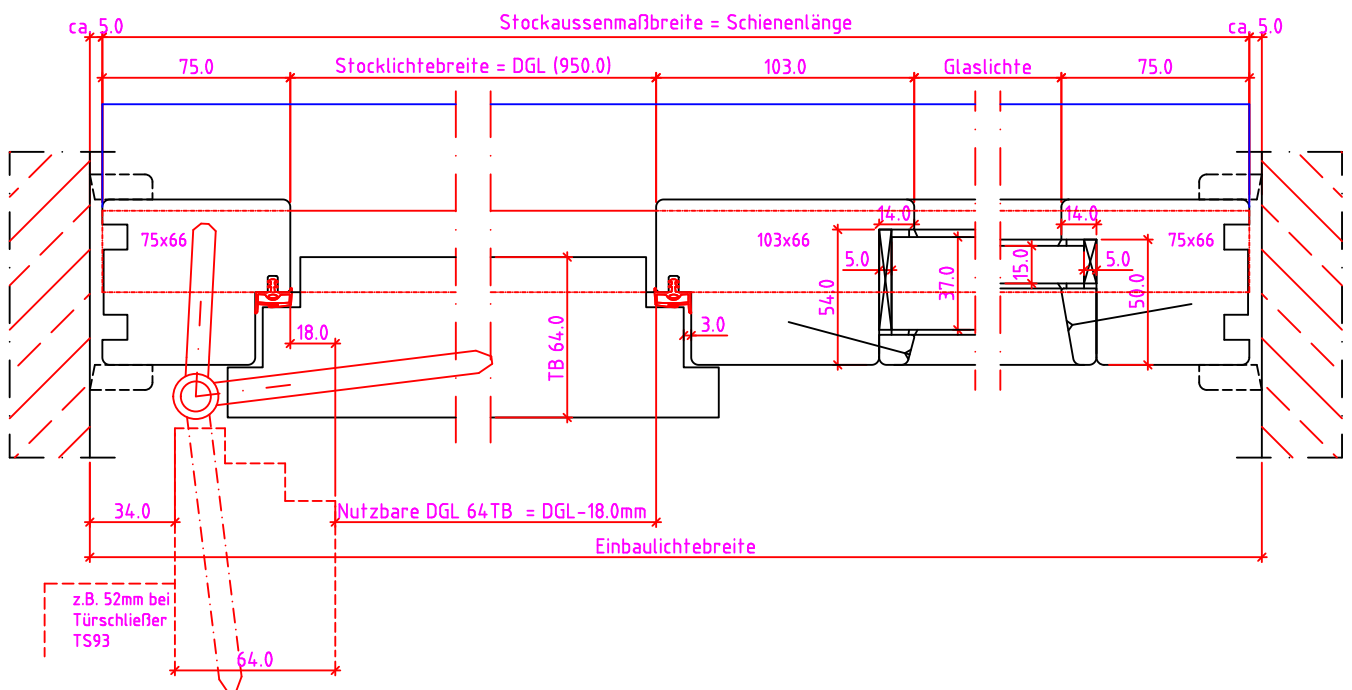
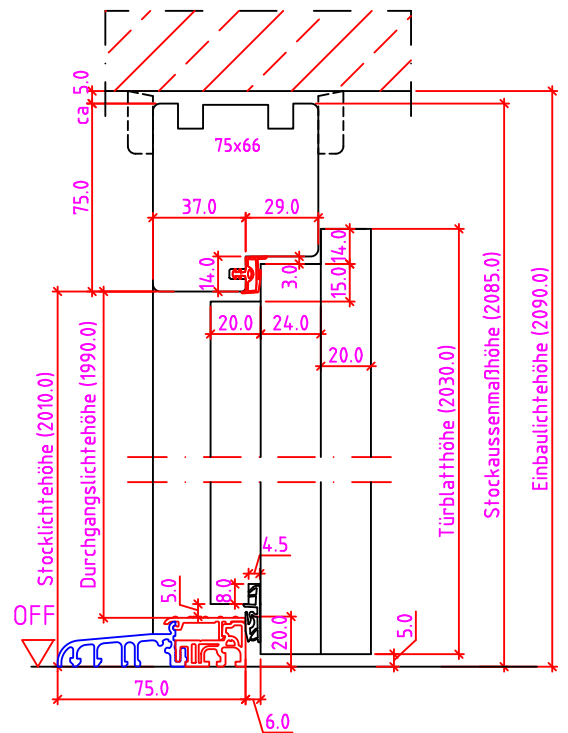

Maßangaben in mm

	Datum	Name	Objekt:	Maßstab:	 <p>Jeld-Wen Türen GmbH A-4582 Spital am Pyhrn</p>
Gez.:	20-10-2016	gsu	Kunde/Lieferant:		
Gepr.:	06.07.17	gsu	AB-Nr.:		
Benennung:	Nutzbare DGL RSTA 75/66 gefälzt (EI30) 64mm Eiffel Bodenschiene			Zeichnungs-Nr.	00787714 / C
Bemerkungen:				Ersatz für:	Alle Rechte vorbehalten